

Integrating Primo and ILS via OVP

8th IGeLU Annual Meeting, Free University, Berlin
September 10, 2013

Alan Ng

University Library System

The Chinese University of Hong Kong

Agenda

- ✦ Background
- ✦ OVP in a nutshell
- ✦ Build your own OVP gateway
- ✦ Demo
- ✦ Summary

Background

Evaluating discovery platforms

- ✦ in 2010, HK PolyU Library started evaluating discovery service
- ✦ 3 candidates: Primo, Summon, EDS

Critical functional criteria

- ✦ strong CJK support
- ✦ unified interface for everything
- ✦ target to replace the Web OPAC

Implied requirements

- ✦ real time availability for physical volumes
- ✦ complete list of physical volumes, library holdings
- ✦ view patron circulation record
- ✦ perform hold request, renewal
- ✦ view reading history, fines record

Choosing Primo for OVP

- ✦ OVP (Opac-via-Primo) is the exact solution
- ✦ only available with Primo
- ✦ a compelling reason to adopt Primo, besides all other technical advantages

First Primo in Hong Kong

- ✦ in 2011 Nov, HK PolyU library soft launched Primo
- ✦ in 2012 Jan, official launch
- ✦ the first ever Primo-Millennium integration with OVP

Primo adoptions continue

- ✦ after HK PolyU, other HK local university libraries continued to adopt
- ✦ The Chinese University of Hong Kong (2013 Jan)
- ✦ The University of Hong Kong (in progress)
- ✦ The Hong Kong University of Science and Technology (in progress)
- ✦ 50% of HK Government funded universities

Primo-Millennium OVP roadmap

- ✦ Primo-Millennium OVP was initially implemented by Ex Libris China team for HK PolyU
- ✦ as a proof of concept, i.e. P-M OVP 1.0
- ✦ not fully implemented, e.g. library holdings not supported
- ✦ completed and enhanced by CUHK Library, i.e. P-M OVP 2.0

OVP in a nutshell

Origin of OVP

- ✦ based on the DLF ILS Discovery Interface Task Group (ILS-DI) Technical Recommendation
- ✦ “Berkeley Accord” signed in 2008 April
- ✦ version 1.1 released in 2008 Dec
- ✦ signed vendors include Talis, Ex Libris, LibLime, BiblioCommons, SirsiDynix, Polaris, VTLIS, California Digital Library, OCLC, AquaBrowser

What is OVP?

- ✦ 3 basic functions
- ✦ Requests (such as hold, ILL booking ... etc)
- ✦ Display of library holdings (locations)
- ✦ Display of the patron's library account (My Account)

How OVP works?

- ✦ Primo talks with ILS via ILS gateway
- ✦ ILS gateway uses an ILS-specific adaptor
- ✦ adaptors for Alma, Aleph, Voyager, Talis
- ✦ NO adaptor for III Millennium

ILS gateway

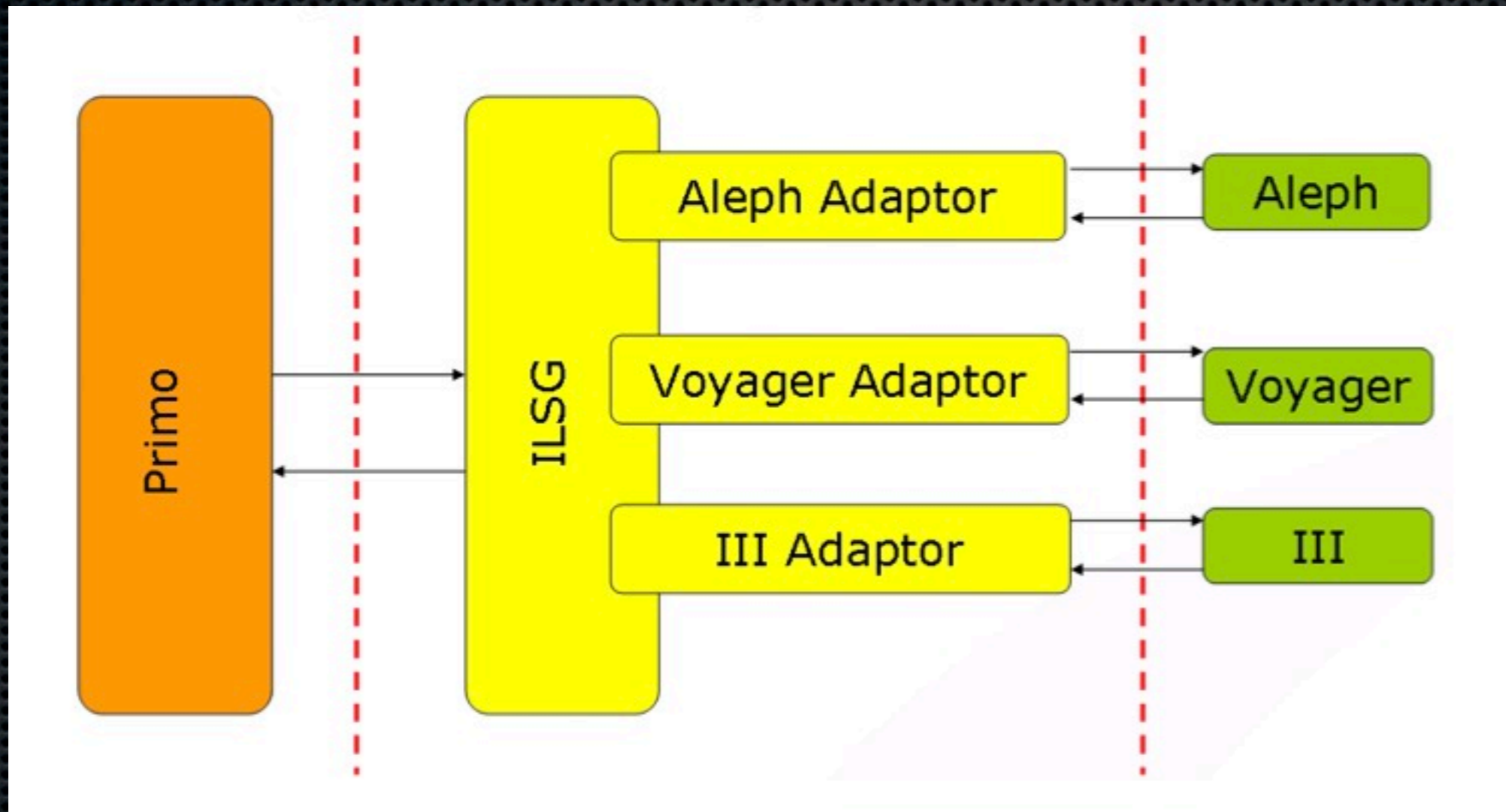

ILS adaptor API

- ✦ for each ILS-specific adaptor, there is a set of API
- ✦ each API is responsible for a specific functional conversation between Primo and the ILS
- ✦ e.g. `get_holdings_info`, `get_loans`, `post_loan_renewal`

ILS adaptor API templates

Primo Back Office [About](#) [Logout](#) [Help](#)

Primo Home > [Advanced Configuration](#) > [All Mapping Tables](#)

ExLibris Primo

Hello Admin

> **Mapping Tables**

Update for Owner: Sub System: Table Name:

Mapping Table Rows

Enabled	ID*	Adaptor ID*	Service Name*	XSLT file	Call Template	Description	Last Updated
<input type="checkbox"/>	<input type="text"/>	<input type="text"/>	<input type="text"/>	<input type="text"/>	<input type="text"/>	<input type="text"/>	<input type="text"/>
<input checked="" type="checkbox"/>	90033	ALEPH_22	get_service_params_Photocopy	aleph_getServicesItemPhotocopy	{{api_base}}/rest	aleph photocopy	08/10/13 By primo Delete
<input checked="" type="checkbox"/>	90034	ALEPH_22	put_request_item_photocopy	put_request_item_photocopy	{{api_base}}/rest	SR11	08/10/13 By primo Delete
<input checked="" type="checkbox"/>	10001	ALEPH_20	post_patron_information	post_patron_information_r	{{api_base}}/rest	BA13 (POST)	03/26/12 By primo Delete
<input checked="" type="checkbox"/>	10002	ALEPH_20	get_patron_information	get_patron_information.xsl	{{api_base}}/rest	BA12	03/26/12 By primo Delete
<input checked="" type="checkbox"/>	10003	ALEPH_20	get_counters	get_counters.xsl	{{api_base}}/rest	BA1	03/26/12 By primo Delete
<input checked="" type="checkbox"/>	60001	ALEPH_20	get_services_and_params1	getServicesGeneral.xsl	{{api_base}}/rest	SR1	03/26/12 By primo Delete
<input checked="" type="checkbox"/>	60002	ALEPH_20	put_request_title_hold	put_request_title_hold_rep	{{api_base}}/rest	SR5	03/26/12 By primo Delete
<input checked="" type="checkbox"/>	60003	ALEPH_20	get_service_params_title_shortloan	get_service_params_title_shortloan	{{api_base}}/rest	SL1	03/26/12 By primo Delete
<input checked="" type="checkbox"/>	60004	ALEPH_20	get_service_params_shortloan	get_service_params_shortloan	{{api_base}}/rest	SL2	03/26/12 By primo Delete
<input checked="" type="checkbox"/>	60005	ALEPH_20	put_request_title_shortloan	put_request_title_shortloan	{{api_base}}/rest	SL3 (PUT)	03/26/12 By primo Delete
<input checked="" type="checkbox"/>	60006	ALEPH_20	put_request_item_shortloan	put_request_item_shortloan	{{api_base}}/rest	SL4 (PUT)	03/26/12 By primo Delete
<input checked="" type="checkbox"/>	60007	ALEPH_20	get_holdings_info	get_holdings_info.xsl	{{api_base}}/rest	1/2 URLs	03/26/12 By primo Delete
<input checked="" type="checkbox"/>	60008	ALEPH_20	get_holdings_info	get_holdings_info.xsl	{{api_base}}/rest	2/2 URLs	03/26/12 By primo Delete

API templates examples

- ✦ `get_holdings_info`

- ✦ `{{api_base}}/rest-dlf/record/{{record_id}}/holdings?lang={{lang}}
&view=full&patron={{patron_id}}&volume={{volume}}&year={{year}}
&sublibrary={{sublibrary}}&sublibs={{sublibs}}&startPos={{startPos}}
&noItems={{noItems}}`

- ✦ `get_loans`

- ✦ `{{api_base}}/rest-dlf/patron/{{patron_id}}/circulationActions/loans?lang={{lang}}
&view=brief&type={{type}}&institution={{institute}}&no_loans={{no_loans}}`

- ✦ `post_loan_renewal`

- ✦ `{{api_base}}/rest-dlf/patron/{{patron_id}}/circulationActions/loans/{{loan_id}}?
lang={{lang}}`

Build your own ILS gateway

Emulate Aleph gateway

- ✦ Millennium didn't implement the adaptor API at all
- ✦ difficult to implement from scratch
- ✦ And ... it is NOT really necessary
- ✦ make use of the Aleph adaptor API syntax
- ✦ build your web services to respond like Aleph

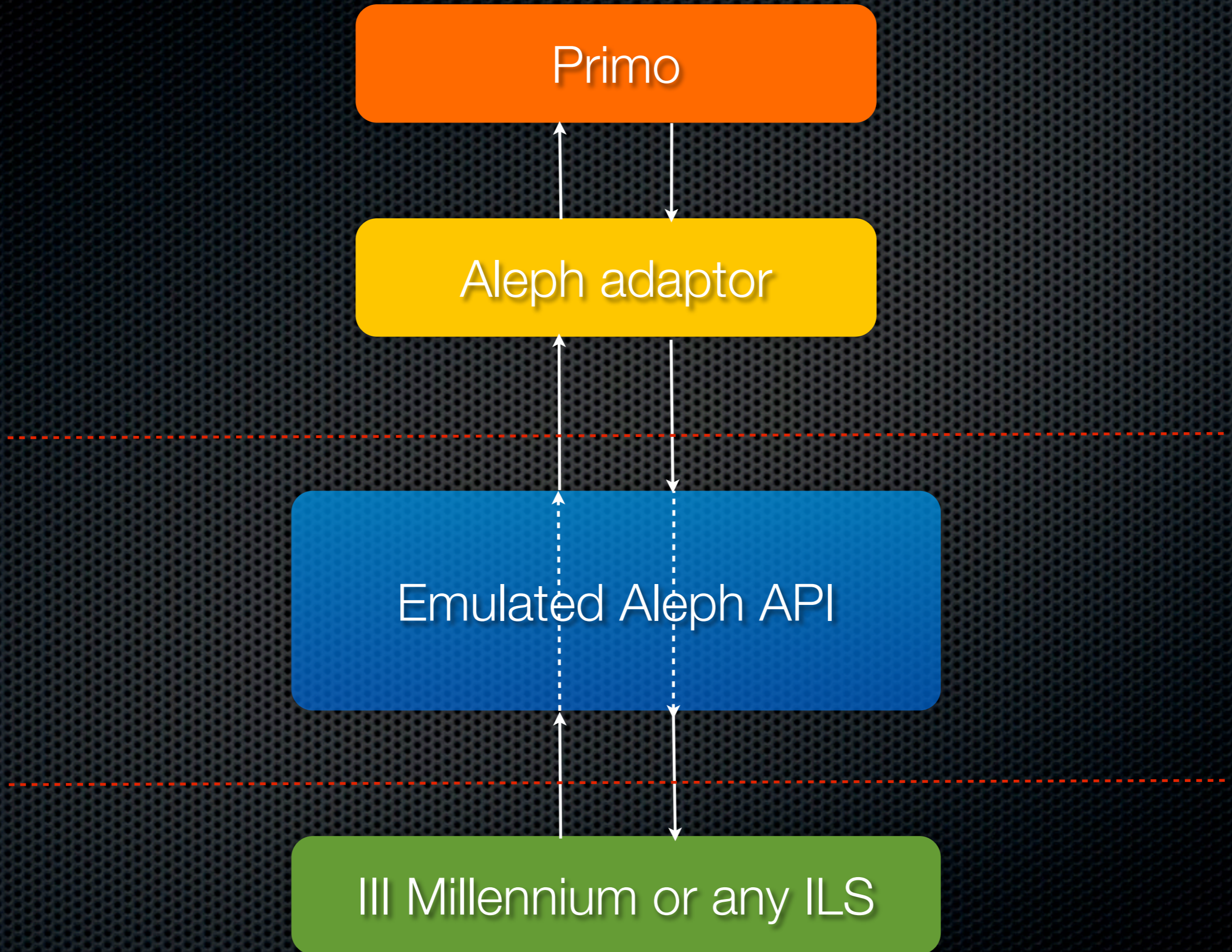

How to emulate?

- ✦ learn how Aleph responds to Primo
- ✦ get all the relevant responds from your Web OPAC
- ✦ by web scraping
- ✦ translate your OPAC responds into Aleph API format
- ✦ Primo feels like talking with an Aleph

How to respond like Aleph?

- ✦ 30+ APIs for communication between Primo and Aleph
- ✦ related to Patron and Bibliographic records

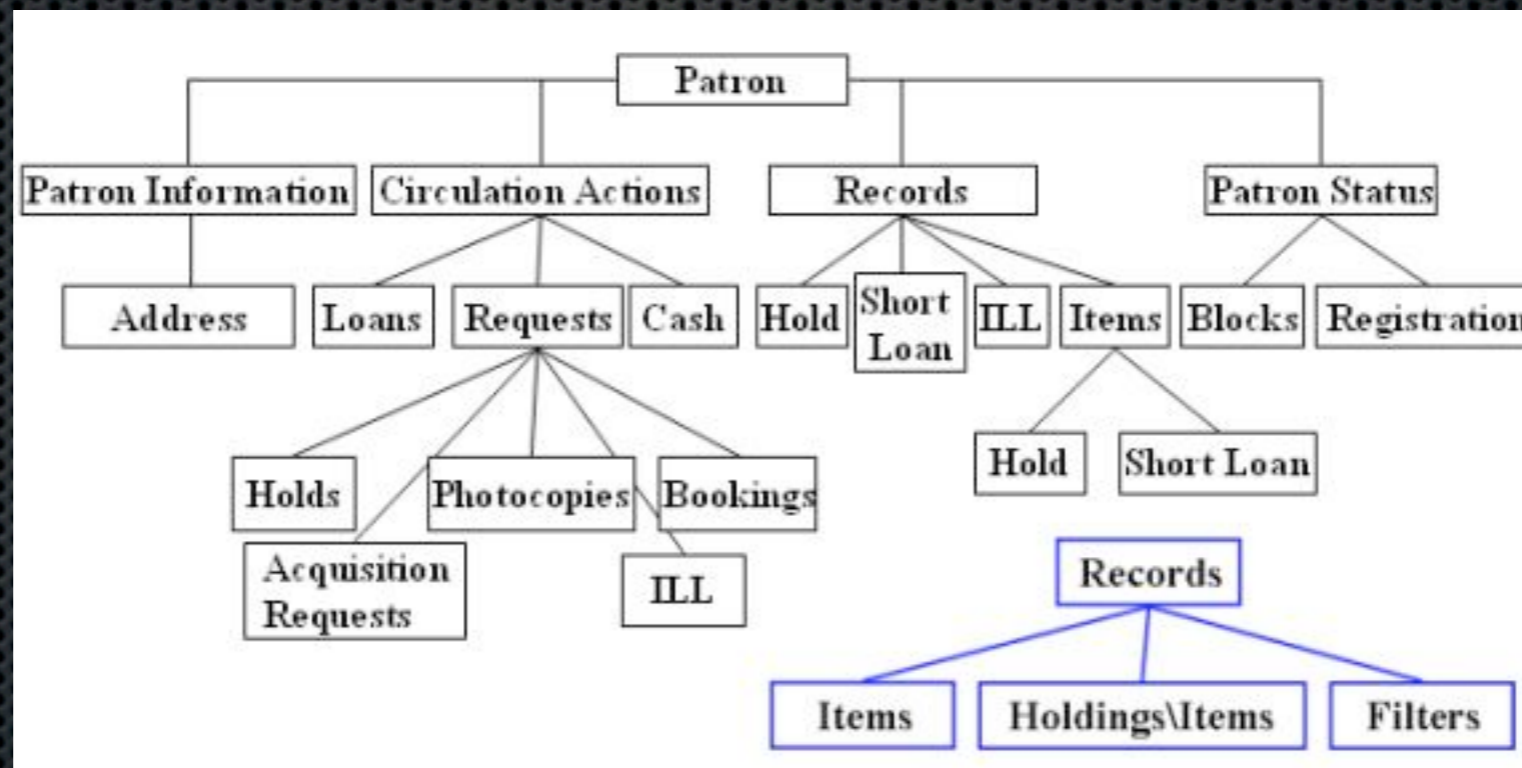

Patron related API

[Patrons](#)

[Patrons](#) > [Patron Information](#)

[Patrons](#) > [Patron Information](#) > [address](#)

[Patrons](#) > [Circulation actions](#)

[Patrons](#) > [Circulation actions](#) > [Loans](#)

[Patrons](#) > [Circulation actions](#) > [requests](#)

[Patrons](#) > [Circulation actions](#) > [requests](#) > [Holds](#)

[Patrons](#) > [Circulation actions](#) > [requests](#) > [ILL](#)

[Patrons](#) > [Circulation actions](#) > [requests](#) > [Photocopies](#)

[Patrons](#) > [Circulation actions](#) > [requests](#) > [Acquisition Requests](#)

[Patrons](#) > [Circulation actions](#) > [requests](#) > [Booking](#)

[Patrons](#) > [Circulation actions](#) > [Cash](#)

[Patrons](#) > [Records](#) (per patron)

[Patrons](#) > [Records](#) (per patron) > [ILL](#) (per Title)

[Patrons](#) > [Records](#) (per patron) > [Holds](#) (per Title) > [Consortial Hold Groups](#)

[Patrons](#) > [Records](#) (per patron) > [Holds](#) (per Title) > [Institutional Hold Group](#)

[Patrons](#) > [Records](#) (per patron) > [Short Loan](#) (per Title)

[Patrons](#) > [Records](#) (per patron) > [Items](#)

[Patrons](#) > [Records](#) (per patron) > [Items](#) > [Hold](#) (per Item)

[Patrons](#) > [Records](#) (per patron) > [Items](#) > [Short Loan](#) (per Item)

[Patrons](#) > [Records](#) (per patron) > [Items](#) > [Photo](#) (per Item)

[Patrons](#) > [Patron Status](#)

[Patrons](#) > [Patron Status](#) > [Blocks](#)

[Patrons](#) > [Patron Status](#) > [Registration](#)

BIB records related API



Services related to bibliographic records, including Holdings and Items information:

[Records](#)

[Records > Items](#)

[Records > Holdings / Items](#)

[Records > Filters](#)

Aleph API examples

- ✦ full list of items for a BIB record
 - ✦ <http://il-aleph07:1893/rest-dlf/record/USM01000050362/items>
- ✦ holdings list for a BIB record
 - ✦ <http://il-aleph07:1893/rest-dlf/record/USM01000050362/holdings>
- ✦ loan list for a patron
 - ✦ <http://il-aleph07:1893/rest-dlf/patron/00000036/circulationActions/loans>
- ✦ item level hold request
 - ✦ <http://il-aleph07:1893/rest-dlf/patron/00000036/record/USM01000050362/items/USM50000238843000390/hold>

Aleph API definitions

- EL Commons > CodeShare > Aleph Open Interfaces > RESTful APIs

The screenshot shows the EL Commons CodeShare website. The top navigation bar includes the logo, the user name "Hello Alan Ng (Log Out)", and a link to the "EL Commons Wiki". Below the navigation bar is a breadcrumb trail: "You are here: EL Commons > CodeShare > Aleph Open Interfaces > RESTful APIs". A search box with a "Go" button is also present. The main content area features a horizontal menu with various library systems: Aleph, Voyager, Primo, MetaLib, SFX, bX, Verde, Rosetta, DigiTool, Cross Product, Presentations, and an RSS feed builder. On the left, a sidebar menu lists various services, with "RESTful APIs" highlighted. The main content area displays the page title "RESTful APIs" and a "Table of Contents" section. The "Table of Contents" is enclosed in a light green box and lists the following items:

- [RESTful APIs](#)
 - [Short introduction](#)
 - [Patron related APIs](#)
 - [Bib. Records related APIs](#)

Get the responds from your ILS

- ✦ knowing how to talk like Aleph, next step is to get the essential information from the ILS
- ✦ Millennium doesn't allow you to implement any custom-made API
- ✦ Work Around: get data from the Web OPAC

Generate Aleph responses

- ✦ use Apache mod_rewrite (.htaccess) to redirect the ILS adaptor API syntax to the CGI script
- ✦ the script uses the Perl LWP::UserAgent web user agent class to talk with ILS web OPAC
- ✦ it uses web scraping to retrieve data
- ✦ it re-packages the data into Aleph API responses

BIB record display on web OPAC

The Chinese University of Hong Kong /All Locations
library.cuhk.edu.hk/record=b2958727

The Chinese University of Hong Kong
University Library System

Start Over Add to My Lists Export MARC Display Another Search

RECORD # : b2958727 Entire Collection Search
 Limit results to available items

Author [Hawking, S. W. \(Stephen W.\)](#)
Title **The illustrated a brief history of time / Stephen Hawking.**
Publisher New York : Bantam Books, 1996.
Edition Updated and expanded ed.



Permanent URL for this record: <http://library.cuhk.edu.hk/record=b2958727-S15>
[\[see this in Easy Search\]](#)

LOCATION	CALL NO.	STATUS
UL	QB981.H377 1996	NOT CHCKD OUT

Subject [Cosmology.](#)
Note "A Labyrinth book"--T.p. verso.
Originally published: A brief history of time. New York : Bantam Books, 1988.
Includes index.

Other Author [Hawking, S. W. \(Stephen W.\). Brief history of time.](#)
Descript 248 p. : col. ill. ; 25 cm.
ISBN 0553103741

Start Over Add to My Lists Export MARC Display Another Search

API response: Full list of items for a BIB record

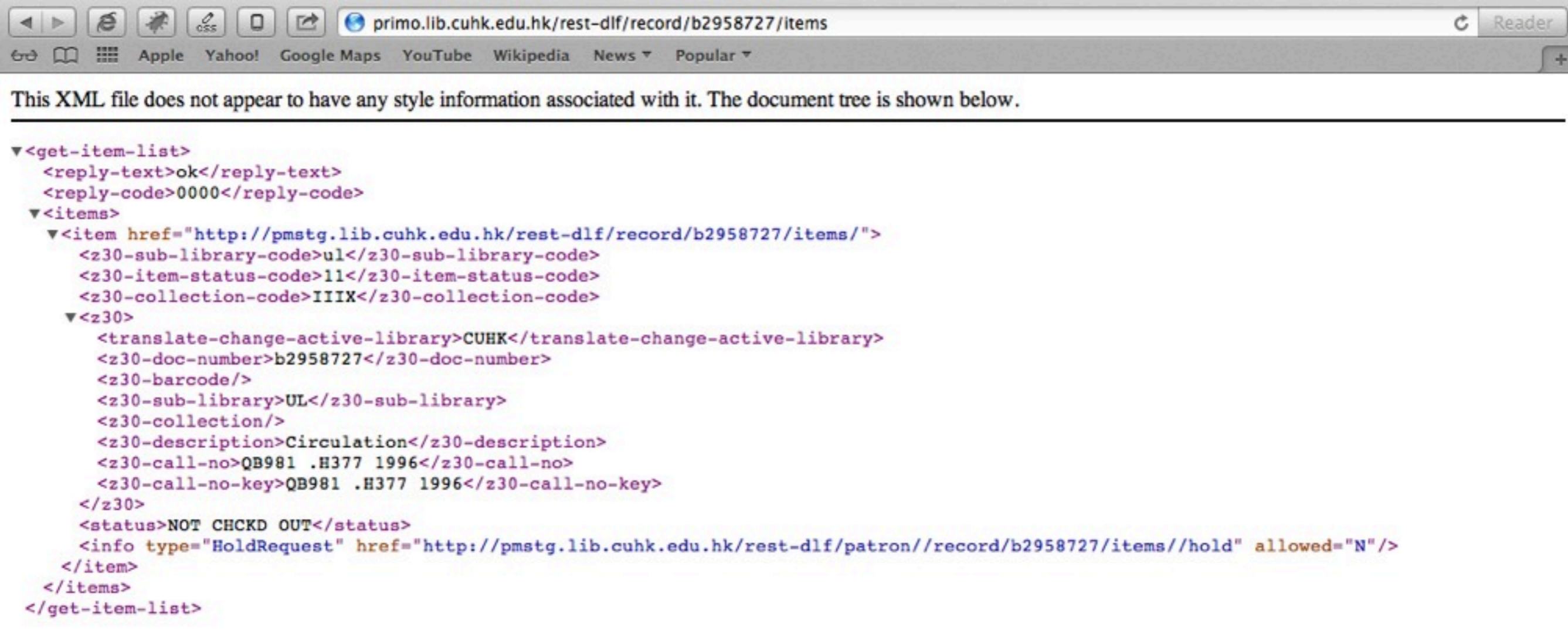



The screenshot shows a web browser window with the address bar containing the URL `primo.lib.cuhk.edu.hk/rest-dlf/record/b2958727/items`. The browser's toolbar includes navigation buttons and a search bar with various search engines like Apple, Yahoo!, Google Maps, YouTube, Wikipedia, News, and Popular. Below the browser window, a message states: "This XML file does not appear to have any style information associated with it. The document tree is shown below." The XML content is displayed in a monospaced font with syntax highlighting. It starts with a root element `<get-item-list>` containing a `<reply-text>` of "ok" and a `<reply-code>` of "0000". The main data is in an `<items>` element, which contains a single `<item>` element. This item has a `href` attribute pointing to the same URL. It includes several `<z30>` elements: `<z30-sub-library-code>` "ul", `<z30-item-status-code>` "11", `<z30-collection-code>` "IIIX", `<z30>` (parent) with `<translate-change-active-library>` "CUHK", `<z30-doc-number>` "b2958727", `<z30-sub-library>` "UL", `<z30-description>` "Circulation", `<z30-call-no>` "QB981 .H377 1996", and `<z30-call-no-key>` "QB981 .H377 1996". The item also has a `<status>` of "NOT CHECKD OUT" and an `<info type="HoldRequest" href="http://pmstg.lib.cuhk.edu.hk/rest-dlf/patron//record/b2958727/items//hold" allowed="N"/>` element.

```
<get-item-list>
  <reply-text>ok</reply-text>
  <reply-code>0000</reply-code>
  <items>
    <item href="http://pmstg.lib.cuhk.edu.hk/rest-dlf/record/b2958727/items/">
      <z30-sub-library-code>ul</z30-sub-library-code>
      <z30-item-status-code>11</z30-item-status-code>
      <z30-collection-code>IIIX</z30-collection-code>
      <z30>
        <translate-change-active-library>CUHK</translate-change-active-library>
        <z30-doc-number>b2958727</z30-doc-number>
        <z30-barcode/>
        <z30-sub-library>UL</z30-sub-library>
        <z30-collection/>
        <z30-description>Circulation</z30-description>
        <z30-call-no>QB981 .H377 1996</z30-call-no>
        <z30-call-no-key>QB981 .H377 1996</z30-call-no-key>
      </z30>
      <status>NOT CHECKD OUT</status>
      <info type="HoldRequest" href="http://pmstg.lib.cuhk.edu.hk/rest-dlf/patron//record/b2958727/items//hold" allowed="N"/>
    </item>
  </items>
</get-item-list>
```

Holdings display for a BIB record on web OPAC

The Chinese University of Hong Kong /All Locations
library.cuhk.edu.hk/record=b1466147

 **The Chinese University of Hong Kong
University Library System** 

[Start Over](#) [Add to My Lists](#) [Export](#) [MARC Display](#) [Another Search](#)

RECORD # : b1466147 Entire Collection : Search
 Limit results to available items

Title Ping guo ri bao = Apple daily.
蘋果日報 = Apple daily.

Publisher Hong Kong : Ping guo ri bao you xian gong si, 1995-
香港 : 蘋果日報有限公司, 1995-

Permanent URL for this record: <http://library.cuhk.edu.hk/record=b1466147-S15>
[\[see this in Easy Search\]](#)

Location	UL Newspaper
CALL NO.	AN1.H6 P5
Identity	Print version
Coverage	UL keeps current month only
Location	UC Newspaper
CALL NO.	AN1.H6 P5
Identity	Print version
Coverage	UC keeps current week only
Location	NA Newspaper
CALL NO.	AN1.H6 P5
Identity	Print version
Coverage	NA keeps current two weeks only
Location	CC Newspaper
CALL NO.	AN1.H6 P5
Identity	Print version
Coverage	CC keeps current week only

Subject [Hong Kong \(China\) -- Newspapers.](#)

Note Issued also online.

Other Title Apple daily

Descript v. : ill. (some col.) ; 58 cm.

Current Freq 日刊

Publ Hist 1995年6月20日-

[Start Over](#) [Add to My Lists](#) [Export](#) [MARC Display](#) [Another Search](#)

API response: Holdings list for a BIB record

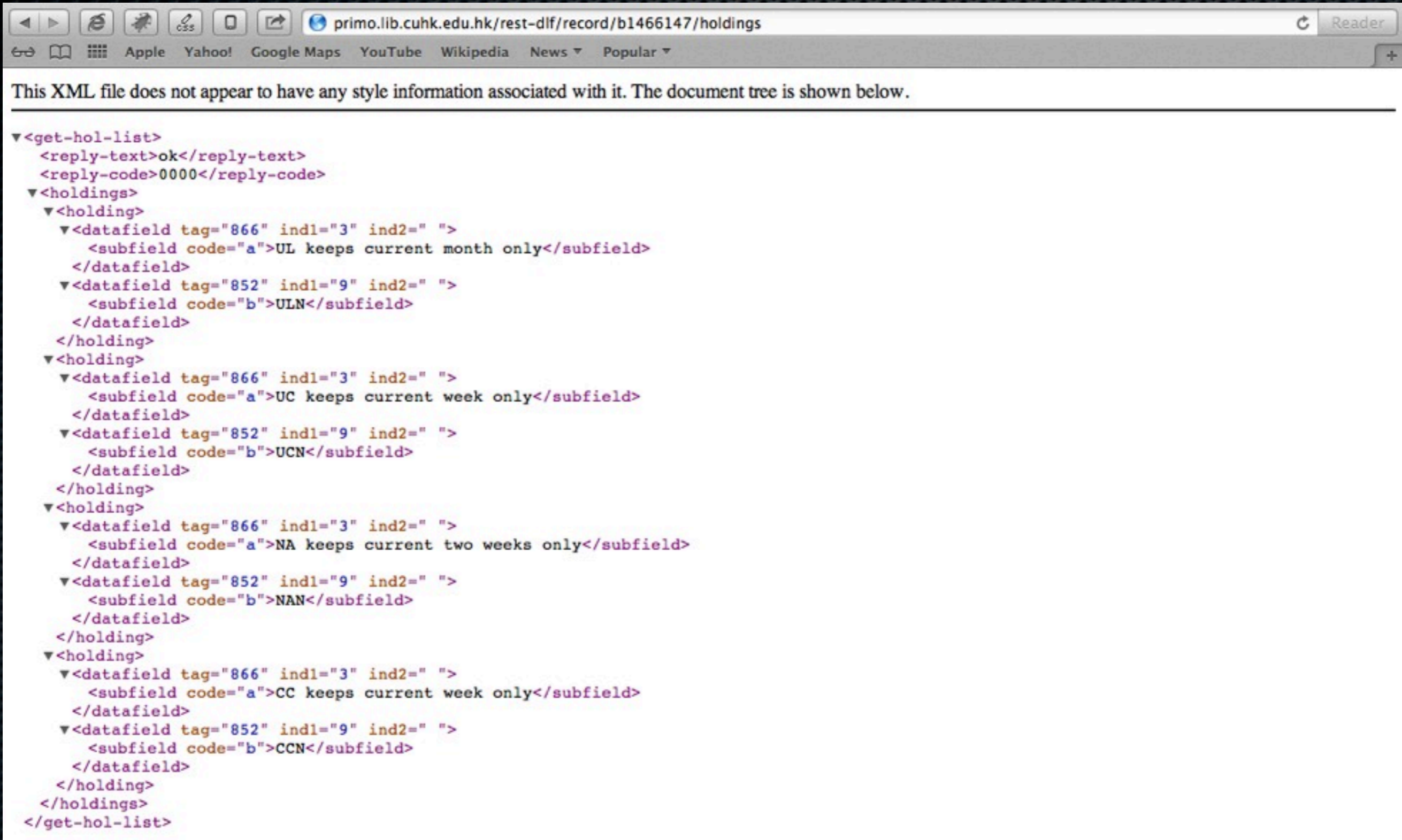

```
<get-hol-list>
  <reply-text>ok</reply-text>
  <reply-code>0000</reply-code>
  <holdings>
    <holding>
      <datafield tag="866" ind1="3" ind2=" " >
        <subfield code="a">UL keeps current month only</subfield>
      </datafield>
      <datafield tag="852" ind1="9" ind2=" " >
        <subfield code="b">ULN</subfield>
      </datafield>
    </holding>
    <holding>
      <datafield tag="866" ind1="3" ind2=" " >
        <subfield code="a">UC keeps current week only</subfield>
      </datafield>
      <datafield tag="852" ind1="9" ind2=" " >
        <subfield code="b">UCN</subfield>
      </datafield>
    </holding>
    <holding>
      <datafield tag="866" ind1="3" ind2=" " >
        <subfield code="a">NA keeps current two weeks only</subfield>
      </datafield>
      <datafield tag="852" ind1="9" ind2=" " >
        <subfield code="b">NAN</subfield>
      </datafield>
    </holding>
    <holding>
      <datafield tag="866" ind1="3" ind2=" " >
        <subfield code="a">CC keeps current week only</subfield>
      </datafield>
      <datafield tag="852" ind1="9" ind2=" " >
        <subfield code="b">CCN</subfield>
      </datafield>
    </holding>
  </holdings>
</get-hol-list>
```

Full loan list for a patron on web OPAC



The Chinese University of Hong Kong University Library System



You are logged into The Chinese University of Hong Kong /All Locations as NG Chi Kit Alan

NG Chi Kit Alan
CARD EXP DATE:07-10-2014
alanng@cuhk.edu.hk

LOG OUT

[Modify your PIN](#)

[2 requests \(holds\). 1 ready for pickup.](#)

[Search the Catalog](#)

[Preferred Searches](#)

[My Reading History](#)

[My Lists](#)

[Add / Update Your E-mail Address](#)

[Go to / Update Your Illiad Account](#)

[My Ratings](#)

[\\$3.00 in unpaid fines and bills](#)

SORT BY DATE CHECKED OUT

RENEW ALL

RENEW SELECTED ITEMS

33 ITEMS CHECKED OUT

RENEW	TITLE	Ratings	BARCODE	STATUS	CALL NUMBER
<input type="checkbox"/>	880-02 Nü ji zhe shou ji / Yishu.	★★★★★	106158989ctyu	DUE 12-09-13 Renewed 2 times	PL2867.Z75 N825 2012
<input type="checkbox"/>	實在平凡的奇異遭遇 / 亦舒.	★★★★★	319950097619459iedl	DUE 28-09-13 Renewed 2 times	PL2867.Z75 S437 2011 1
<input type="checkbox"/>	櫻唇 / 亦舒	★★★★★	310003508484239lulb	DUE 28-09-13 Renewed 2 times	PL2867.Z75 Y564 2012

API response: Loan list for a patron

```
primo.lib.cuhk.edu.hk/rest-dlf/patron/459823/circulationActions/loans?type=active
Reader
This XML file does not appear to have any style information associated with it. The document tree is shown below.
▼ <pat-loan-list>
  <reply-text>ok</reply-text>
  <reply-code>0000</reply-code>
  ▼ <loans>
    <translate-change-active-library>CUHK</translate-change-active-library>
    ▼ <institution code="CUHK">
      <inst-name>CUHK</inst-name>
      ▶ <loan renew="Y" href="http://pmstg.lib.cuhk.edu.hk/rest-dlf/patron/502984/circulationActions/loans/i216697389ctyu">...</loan>
      ▼ <loan renew="Y" href="http://pmstg.lib.cuhk.edu.hk/rest-dlf/patron/502984/circulationActions/loans/i201706789ied1">
        <z36-sub-library-code>CIR</z36-sub-library-code>
        <z36-rec-key/>
        <z36-status>Active</z36-status>
        <z36-due-date>DUE 28-09-13</z36-due-date>
        <z36-due-hour/>
        <z36-recall-date>00000000</z36-recall-date>
        <z36-recall-due-date>00000000</z36-recall-due-date>
        <z36-sub-library>PL2867.275 S437 2011 1</z36-sub-library>
        <z30-description/>
        <z13-author>319950097619459ied1</z13-author>
        <z13-title>實在平凡的奇異遭遇 / 亦舒.</z13-title>
        <z13-year/>
        <fine/>
      </loan>
      ▼ <loan renew="Y" href="http://pmstg.lib.cuhk.edu.hk/rest-dlf/patron/502984/circulationActions/loans/i166254889lulb">
        <z36-sub-library-code>CIR</z36-sub-library-code>
        <z36-rec-key/>
        <z36-status>Active</z36-status>
        <z36-due-date>DUE 28-09-13</z36-due-date>
        <z36-due-hour/>
        <z36-recall-date>00000000</z36-recall-date>
        <z36-recall-due-date>00000000</z36-recall-due-date>
        <z36-sub-library>PL2867.275 Y564 2012</z36-sub-library>
        <z30-description/>
        <z13-author>310003508484239lulb</z13-author>
        <z13-title>櫻唇 / 亦舒</z13-title>
        <z13-year/>
        <fine/>
      </loan>
      ▶ <loan renew="Y" href="http://pmstg.lib.cuhk.edu.hk/rest-dlf/patron/502984/circulationActions/loans/i200592589ied1">...</loan>
      ▶ <loan renew="Y" href="http://pmstg.lib.cuhk.edu.hk/rest-dlf/patron/502984/circulationActions/loans/i4268718">...</loan>
      ▶ <loan renew="Y" href="http://pmstg.lib.cuhk.edu.hk/rest-dlf/patron/502984/circulationActions/loans/i4286664">...</loan>
      ▶ <loan renew="Y" href="http://pmstg.lib.cuhk.edu.hk/rest-dlf/patron/502984/circulationActions/loans/i4153928">...</loan>
      ▶ <loan renew="Y" href="http://pmstg.lib.cuhk.edu.hk/rest-dlf/patron/502984/circulationActions/loans/i4331545">...</loan>
      ▶ <loan renew="Y" href="http://pmstg.lib.cuhk.edu.hk/rest-dlf/patron/502984/circulationActions/loans/i4298663">...</loan>
      ▶ <loan renew="Y" href="http://pmstg.lib.cuhk.edu.hk/rest-dlf/patron/502984/circulationActions/loans/i4298674">...</loan>
      ▶ <loan renew="Y" href="http://pmstg.lib.cuhk.edu.hk/rest-dlf/patron/502984/circulationActions/loans/i4331557">...</loan>
      ▶ <loan renew="Y" href="http://pmstg.lib.cuhk.edu.hk/rest-dlf/patron/502984/circulationActions/loans/i4004888">...</loan>
      ▶ <loan renew="Y" href="http://pmstg.lib.cuhk.edu.hk/rest-dlf/patron/502984/circulationActions/loans/i3178298">...</loan>
      ▶ <loan renew="Y" href="http://pmstg.lib.cuhk.edu.hk/rest-dlf/patron/502984/circulationActions/loans/i3000454">...</loan>
      ▶ <loan renew="Y" href="http://pmstg.lib.cuhk.edu.hk/rest-dlf/patron/502984/circulationActions/loans/i3172282">...</loan>
      ▶ <loan renew="Y" href="http://pmstg.lib.cuhk.edu.hk/rest-dlf/patron/502984/circulationActions/loans/i3078340">...</loan>
      ▶ <loan renew="Y" href="http://pmstg.lib.cuhk.edu.hk/rest-dlf/patron/502984/circulationActions/loans/i3174979">...</loan>
      ▶ <loan renew="Y" href="http://pmstg.lib.cuhk.edu.hk/rest-dlf/patron/502984/circulationActions/loans/i3078317">...</loan>
      ▶ <loan renew="Y" href="http://pmstg.lib.cuhk.edu.hk/rest-dlf/patron/502984/circulationActions/loans/i3004065">...</loan>
      ▶ <loan renew="Y" href="http://pmstg.lib.cuhk.edu.hk/rest-dlf/patron/502984/circulationActions/loans/i3004086">...</loan>
      ▶ <loan renew="Y" href="http://pmstg.lib.cuhk.edu.hk/rest-dlf/patron/502984/circulationActions/loans/i3154911">...</loan>
      ▶ <loan renew="Y" href="http://pmstg.lib.cuhk.edu.hk/rest-dlf/patron/502984/circulationActions/loans/i4258157">...</loan>
      ▶ <loan renew="Y" href="http://pmstg.lib.cuhk.edu.hk/rest-dlf/patron/502984/circulationActions/loans/i4253962">...</loan>
      ▶ <loan renew="Y" href="http://pmstg.lib.cuhk.edu.hk/rest-dlf/patron/502984/circulationActions/loans/i4235272">...</loan>
      ▶ <loan renew="Y" href="http://pmstg.lib.cuhk.edu.hk/rest-dlf/patron/502984/circulationActions/loans/i4030252">...</loan>
      ▶ <loan renew="Y" href="http://pmstg.lib.cuhk.edu.hk/rest-dlf/patron/502984/circulationActions/loans/i3646200">...</loan>
      ▶ <loan renew="Y" href="http://pmstg.lib.cuhk.edu.hk/rest-dlf/patron/502984/circulationActions/loans/i3519927">...</loan>
      ▶ <loan renew="Y" href="http://pmstg.lib.cuhk.edu.hk/rest-dlf/patron/502984/circulationActions/loans/i3912078">...</loan>
      ▶ <loan renew="Y" href="http://pmstg.lib.cuhk.edu.hk/rest-dlf/patron/502984/circulationActions/loans/i4314101">...</loan>
      ▶ <loan renew="Y" href="http://pmstg.lib.cuhk.edu.hk/rest-dlf/patron/502984/circulationActions/loans/i3905897">...</loan>
      ▶ <loan renew="Y" href="http://pmstg.lib.cuhk.edu.hk/rest-dlf/patron/502984/circulationActions/loans/i4290785">...</loan>
      ▶ <loan renew="Y" href="http://pmstg.lib.cuhk.edu.hk/rest-dlf/patron/502984/circulationActions/loans/i4290803">...</loan>
      ▶ <loan renew="Y" href="http://pmstg.lib.cuhk.edu.hk/rest-dlf/patron/502984/circulationActions/loans/i4287679">...</loan>
    </institution>
  </loans>
</pat-loan-list>
```

Hold request list for a patron on web OPAC



The Chinese University of Hong Kong University Library System



You are logged into The Chinese University of Hong Kong /All Locations as NG Chi Kit Alan

NG Chi Kit Alan
CARD EXP DATE:07-10-2014
alanng@cuhk.edu.hk

LOG OUT

- [Modify your PIN](#)
- [33 Items currently checked out](#)
- [Search the Catalog](#)
- [Preferred Searches](#)
- [My Reading History](#)
- [My Lists](#)
- [Add / Update Your E-mail Address](#)
- [Go to / Update Your Illiad Account](#)
- [My Ratings](#)
- [\\$3.00 in unpaid fines and bills](#)

Sort by Hold Requested Date CANCEL ALL CANCEL SELECTED ITEMS

2 HOLDS

CANCEL	TITLE	Ratings	STATUS	PICKUP LOCATION	CANCEL IF NOT FILLED BY
<input type="checkbox"/>	A brief history of time / Stephen Hawking.	★★★★★	Ready. Must pick up by 04-09-13	University Library	
<input type="checkbox"/>	Stephen Hawking's A brief history of time : a reader's companion / edited by Stephen Hawking : prepared by Gene Stone.	★★★★★	DUE 10-09-13	University Library	

Sort by Hold Requested Date CANCEL ALL CANCEL SELECTED ITEMS

API response: Hold list for a patron

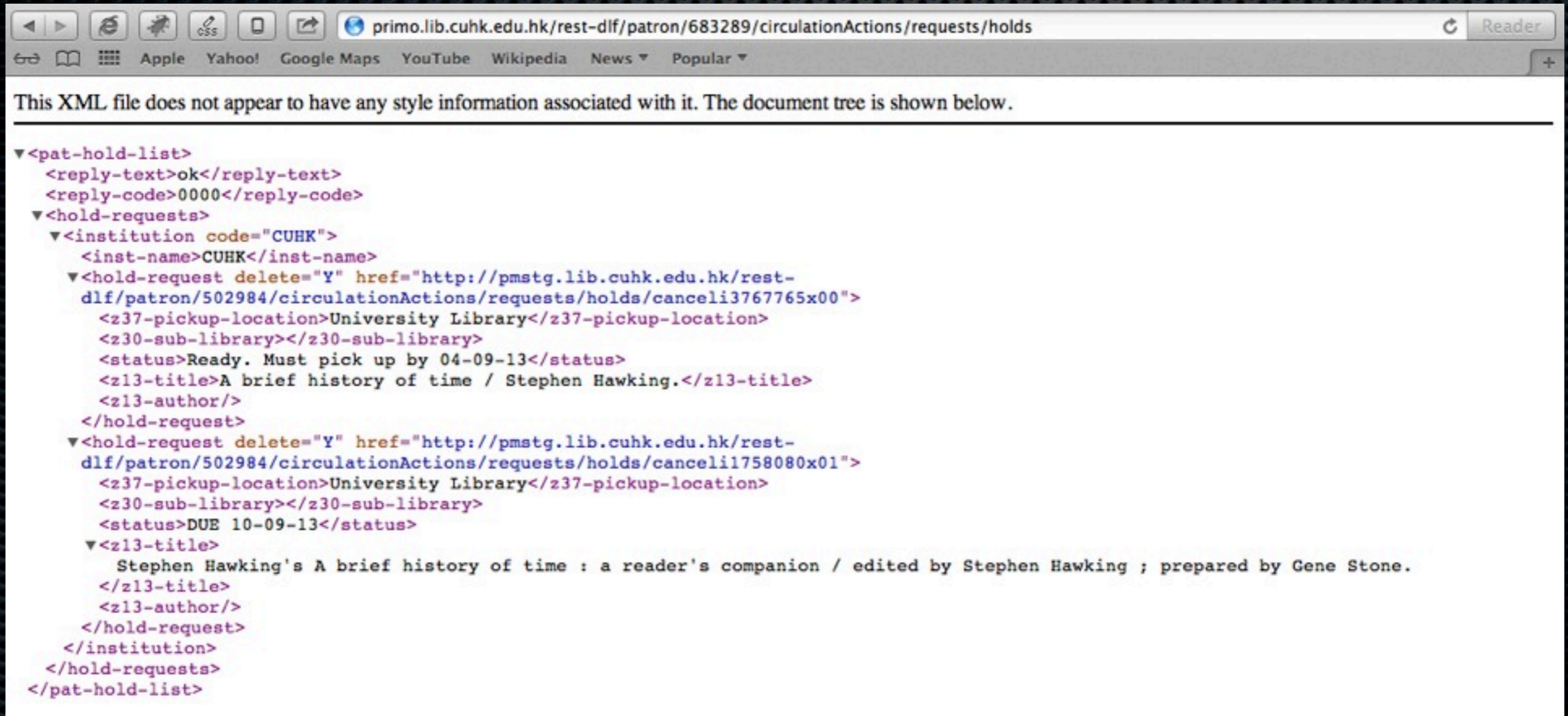

The screenshot shows a web browser window with the address bar containing the URL: `primo.lib.cuhk.edu.hk/rest-dlf/patron/683289/circulationActions/requests/holds`. The browser's address bar also shows navigation icons and a search bar. Below the address bar, there is a message: "This XML file does not appear to have any style information associated with it. The document tree is shown below." The XML document tree is displayed in a tree view, showing the following structure:

```
<pat-hold-list>
  <reply-text>ok</reply-text>
  <reply-code>0000</reply-code>
  <hold-requests>
    <institution code="CUHK">
      <inst-name>CUHK</inst-name>
      <hold-request delete="Y" href="http://pmstg.lib.cuhk.edu.hk/rest-dlf/patron/502984/circulationActions/requests/holds/canceli3767765x00">
        <z37-pickup-location>University Library</z37-pickup-location>
        <z30-sub-library></z30-sub-library>
        <status>Ready. Must pick up by 04-09-13</status>
        <z13-title>A brief history of time / Stephen Hawking.</z13-title>
        <z13-author/>
      </hold-request>
      <hold-request delete="Y" href="http://pmstg.lib.cuhk.edu.hk/rest-dlf/patron/502984/circulationActions/requests/holds/canceli1758080x01">
        <z37-pickup-location>University Library</z37-pickup-location>
        <z30-sub-library></z30-sub-library>
        <status>DUE 10-09-13</status>
        <z13-title>
          Stephen Hawking's A brief history of time : a reader's companion / edited by Stephen Hawking ; prepared by Gene Stone.
        </z13-title>
        <z13-author/>
      </hold-request>
    </institution>
  </hold-requests>
</pat-hold-list>
```

Demo

List of all physical items of a book title

Books Articles Books & Articles Extended Search

a brief history of time Entire Collection Advanced Search Browse Search Search HKALL

rss
Add page to e-Shelf

Show only
Full Text Online (181)

Refine My Results

Subject
History, Asia, Australia and Oceania (13)
Engineering (11)
Music (11)
United States (10)
Cosmology (10)
More options

Author
SpringerLink (Online service) (28)
ebrary, Inc (21)
Hawking, S (8)
ScienceDirect (Online service) (7)
Books24x7, Inc (6)
More options

Resource Type
Book (622)
E-Book (66)
DVD (2)
Computer File (1)
More options

Collection
E-Books and E-Theses (181)
Reference Materials (6)
Audio-visual Materials (2)
CUHK Theses (2)
Local TV Programmes (1)
More options

Library
University Library (452)
Chung Chi College Library (58)
Lee Quo Wei Law Library (55)
New Asia College Library (20)

Results 1 - 10 of 785 for Entire Collection Sorted by: Relevance 1 2 3 4 5 → View 6 versions

 **A brief history of time / Stephen Hawking**
S. W. Hawking (Stephen W.)
[Updated tenth anniversary commemorative ed.].. London ; New York : Bantam Press 1998
● Holding: UL Good Reads QB981 .H377 1998b

Book [Locations](#) [Details](#) [Reviews & Tags](#) [Findit@CUHK](#) [Send to](#) [X](#)

Location	Call Number	Status	Request Options
UL Good Reads	QB981 .H377 1998b	ON HOLDSHELF	Sign in to request
UL Good Reads	QB981 .H377 1998b c.2	DUE 29-10-13	Sign in to request

 **The illustrated a brief history of time / Stephen Hawking**
S. W. Hawking (Stephen W.) S. W Hawking (Stephen W.)
Updated and expanded ed.. New York : Bantam Books 1996
● Holding: UL QB981 .H377 1996

Book [Locations](#) [Details](#) [Reviews & Tags](#) [Findit@CUHK](#) [Send to](#) [X](#)

Location	Call Number	Status	Request Options
UL	QB981 .H377 1996	NOT CHCKD OUT	Sign in to request

List of holdings of a journal title

Books Articles Books & Articles Extended Search

journal of management Entire Collection Go Advanced Search Browse Search Search HKALL

Did you mean: journal of arts management?

Results 1 - 10 of 1,064 for Entire Collection Sorted by: Relevance 1 2 3 4 5 →

Refined by: resource type: Journal x

Journal of management
Southern Management Association.
Thousand Oaks, Calif. Sage Publications
● Holding: UL Periodical HD28.J5967

Journal

Locations Details Reviews & Tags Findit@CUHK

UL Periodical HD28.J5967 ● See status

Summary Holdings: UL has v.5, no.1-2 (1979); v.12 (1986)-v.33 (2007);

Location	Call Number	Status	Request Options
UL Periodical	HD28.J5967 v.5, no.1-2, 1979	NOT CHCKD OUT	Sign in to request
UL Periodical	HD28.J5967 v.12, 1986	NOT CHCKD OUT	Sign in to request
UL Periodical	HD28.J5967 v.13, 1987	NOT CHCKD OUT	Sign in to request
UL Periodical	HD28.J5967 v.14, 1988	NOT CHCKD OUT	Sign in to request
UL Periodical	HD28.J5967 v.15, 1989	NOT CHCKD OUT	Sign in to request

View all items

International journal of management
Geelong, Vic. : International Journal of Management 1984-
● Holding: UL Periodical HD28 .I52

Journal

Locations Details Reviews & Tags Findit@CUHK

UL Periodical HD28 .I52 ● See status

Summary Holdings: UL has v.6 (1989)-v.24 (2007);

Location	Call Number	Status	Request Options
UL Periodical	HD28 .I52 v.6, 1989	NOT CHCKD OUT	Sign in to request
UL Periodical	HD28 .I52 v.7, 1990	NOT CHCKD OUT	Sign in to request
UL Periodical	HD28 .I52 v.8, 1991	NOT CHCKD OUT	Sign in to request
UL Periodical	HD28 .I52 v.9, 1992	NOT CHCKD OUT	Sign in to request
UL Periodical	HD28 .I52 v.10, 1993	NOT CHCKD OUT	Sign in to request

View all items

rss
Add page to e-Shelf

Refine My Results

Subject

- Management (181)
- Industrial management (100)
- Personnel management (74)
- Business (56)
- Management information systems (33)

More options

Author

- Hong Kong Institute of Human Resource Management (26)
- American Management Association (14)
- Institute of Management Sciences (12)
- Financial Training Company (10)
- Association of Chartered Certified Accountants (Great Britain) (7)

More options

Collection

- Periodicals (1,064)
- Reference Materials (43)
- Hong Kong Government Documents (40)

More options

Library

- University Library (955)
- Chung Chi College Library (45)
- Lee Quo Wei Law Library (12)
- Architecture Library (11)
- Li Ping Medical Library (7)

More options

Language

- English (909)
- Chinese (131)
- Japanese (17)
- Korean (2)
- German (2)

More options

Making book hold request

Books Articles Books & Articles Extended Search

a brief history of time Entire Collection Advanced Search Browse Search Search HKALL

Results 1 - 10 of 785 for Entire Collection Sorted by: Relevance 1 2 3 4 5 → View 6 versions

 **A brief history of time / Stephen Hawking**
S. W. Hawking (Stephen W.)
[Updated tenth anniversary commemorative ed.].. London ; New York : Bantam Press 1998
● **Holding:** UL Good Reads QB981 .H377 1998b

Book [Locations](#) [Details](#) [Reviews & Tags](#) [Findit@CUHK](#) [Like](#) 0 [Send to](#) [X](#)

Request Options:

Volume:

Location: UL Good Reads

May also be available in other locations. [View All locations.](#)

Show only
Full Text Online (181)

Refine My Results

Subject
History, Asia, Australia and Oceania (13)
Engineering (11)
Music (11)
United States (10)
Cosmology (10)
More options ▾

Author
SpringerLink (Online service) (28)
ebrary, Inc (21)
Hawking, S (8)
ScienceDirect (Online service)

List of current loans

Books Articles Books & Articles Extended Search

journal of management Entire Collection Advanced Search Browse Search Search HKALL

e-Shelf Queries **My Account**

List of Active Loans List of Historic Loans

Renew Selected

#	Title	Barcode	Due Date	Due Hour	Potential Fine	Call Number	Status
1	<input type="checkbox"/> 880-02 Nū ji zhe shou ji / Yishu.	106158989ctyu	DUE 12- 09-13			PL2867.Z75 N825 2012	Renewable
2	<input type="checkbox"/> 實在平凡的奇異遭遇 / 亦舒.	319950097619459iedl	DUE 28- 09-13			PL2867.Z75 S437 2011 1	Renewable
3	<input type="checkbox"/> 櫻唇 / 亦舒	310003508484239lulb	DUE 28- 09-13			PL2867.Z75 Y564 2012	Renewable
4	<input type="checkbox"/> 代尋失去時光 / 亦舒.	319950096526809iedl	DUE 28- 09-13			PL2867.Z75 D35 2011	Renewable
5	<input type="checkbox"/> Mobile usability / Jakob Nielsen, Raluca Budiu.	004802335	DUE 06- 10-13			QA76.59 .N53 2012	Renewable
6	<input type="checkbox"/> 本棚の中のニッポン : 海外の日本図書館と日本研究 = Japanese studies libraries in the world / 江上敏哲.	004795651	DUE 15- 10-13			Z688.J3 E33 2012	Renewable
7	<input type="checkbox"/> HTML, CSS, & JavaScript mobile development for dummies / by William Harrel.	004730276	DUE 15- 10-13			QA76.59 .H373 2011	Renewable
8	<input type="checkbox"/> Learning iPad programming : a hands-on guide to building iPad apps / Kirby Turner, Tom Harrington ; [foreword by Mark Dalrymple].	004848511	DUE 25- 10-13			QA76.8.I863 T87 2013	Renewable
9	<input type="checkbox"/> CSS3 : the missing manual / David Sawyer McFarland.	004822792	DUE 30- 10-13			TK5105.888 .M336 2013	Renewable
10	<input type="checkbox"/> Beginning iOS6 development : exploring the iOS SDK / David Mark ... [et al.].	004822799	DUE 30- 10-13			QA76.8.I64 M36 2013	Renewable
11	<input type="checkbox"/> Learning jQuery : a hands-on guide to building rich interactive web front ends / Ralph Steyer.	004848500	DUE 01- 11-13			QA76.73.J38 S84465 2013	Renewable
12	<input type="checkbox"/> 飢餓遊戲 = The hunger games / 蘇珊·柯林斯著 ; 鄧嘉宛譯.	004540412	DUE 23- 11-13			PS3603.O4558 H86412 2009	Renewable

List of historic loans

Books Articles Books & Articles Extended Search

journal of management Entire Collection Advanced Search Browse Search Search HKALL

e-Shelf Queries **My Account**

Loans (33)
 Requests (2)
 Fine & Fees (1)
 Personal Settings

List of Active Loans **List of Historic Loans**

#	Title	Author	Due Hour	Potential Fine	Location
1	Learning UNIX for Mac OS X Panther	Taylor, Dave, 1962-	17-10-2012		Copy 2
2	Learning UNIX for Mac OS X Panther	Taylor, Dave, 1962-	17-10-2012		Copy 2
3	Learning UNIX for Mac OS X Panther	Taylor, Dave, 1962-	17-10-2012		Copy 2
4	JavaScript : the complete reference	Powell, Thomas A., 1968-	22-10-2012		Copy 1
5	jQuery in action	Bibeault, Bear.	22-10-2012		Copy 1
6	jQuery in action	Bibeault, Bear.	22-10-2012		Copy 1
7	Beginning iOS 5 games development : using the iOS 5 SDK for iPad, iPhone, and iPod Touch	Jordan, Lucas.	22-10-2012		Copy 1
8	jQuery in action	Bibeault, Bear.	22-10-2012		Copy 1
9	HTML, CSS, & JavaScript mobile development for dummies	Harrel, William.	22-10-2012		Copy 1
10	JavaScript : the complete reference	Powell, Thomas A., 1968-	22-10-2012		Copy 1
11	图书馆 : 不落幕的智慧盛宴 = The library : an illustrated history	斯图亚特·A. P.默里(Stuart A. P. Murray)著 ; 胡炜译.	22-10-2012		Copy 1
12	Professional mobile application development		22-10-2012		Copy 1
13	Professional mobile application development		22-10-2012		Copy 1

List of hold request

Books Articles Books & Articles Extended Search

journal of management Entire Collection Advanced Search Browse Search Search HKALL

e-Shelf Queries **My Account**

Loans (33)
Requests (2)
Fine & Fees (!)
Personal Settings

List of Requests

#	Type	Title	Author	Status	Pickup Location	Location	Actions
01	Hold	A brief history of time / Stephen Hawking.		Ready. Must pick up by 04-09-13	University Library		Cancel
02	Hold	Stephen Hawking's A brief history of time : a reader's companion / edited by Stephen Hawking ; prepared by Gene Stone.		DUE 10-09-13	University Library		Cancel

List of fines

Books Articles Books & Articles Extended Search

journal of management Entire Collection Advanced Search Browse Search Search HKALL

e-Shelf Queries **My Account**

Loans (33)
Requests (2)
Fine & Fees (1)
Personal Settings

List of Fines:

#	Title	Date Due	Date Returned	Type	Amount	Transferred
01	HTML, CSS, & JavaScript mobile development for dummies / by William Harrel.	Tue 19 Feb 2013		Debit	\$1.00	No
02	陌生人的糖果 / 亦舒.	Sat 03 Aug 2013	Mon 05 Aug 2013	Debit	\$2.00	No
Fines Balance:					3.0	

Summary

Essential concepts

- ✦ emulate 30+ Aleph RESTful API
- ✦ CGI script to do web scraping from web OPAC
- ✦ works with any ILS with a web OPAC
- ✦ works with Primo 3.X, Primo 4.X ...

Pros and Cons

Pros

works with any web OPAC

native Primo support

easy to maintain

Cons

do it on your own

needs to sync with OPAC

can't retire your web OPAC

References

- DLF ILS Discovery Interface Task Group (ILS-DI) Technical Recommendation -- An API for effective interoperation between integrated library systems and external discovery (http://old.diglib.org/architectures/ilsdi/DLF_ILS_Discovery_1.1.pdf)
- DLF ILS Discovery Interfaces (<http://old.diglib.org/architectures/ilsdi/>)
- California Digital Library news (<http://www.cdlib.org/cdlinfo/2008/08/25/digital-library-federation-dlf-releases-technical-recommendation-from-ils-discovery-interface-task-group/>)
- Primo Interoperability Guide, chapter 8
- Primo - Developing Gateway Adaptor
- Aleph RESTful APIs (<http://www.exlibrisgroup.org/display/AlephOI/RESTful+APIs>)

Q & A

Contact: alanng@cuhk.edu.hk

Thank You