

Cataloguing manuscripts and private archives in Alma

Anders Toftgaard, Senior researcher, PhD
Special Collections

Copenhagen, IGeLU2024
oktober 2024



**DET KGL.
BIBLIOTEK**

Royal Danish Library

Royal Danish Library

In 2017, the State and University Library in Aarhus and The Royal Library in Copenhagen merged.

The Danish National Art Library and the Administrative Library were also part of the merger.

The merger was a result of political aim of consolidating national and university libraries in Denmark

Larsen, Svend. (2020) 'Mergers and digital transformation in Danish research libraries', *ABI-Technik*. Berlin: De Gruyter. Available at: <https://doi.org/10.1515/abitech-2020-2032>

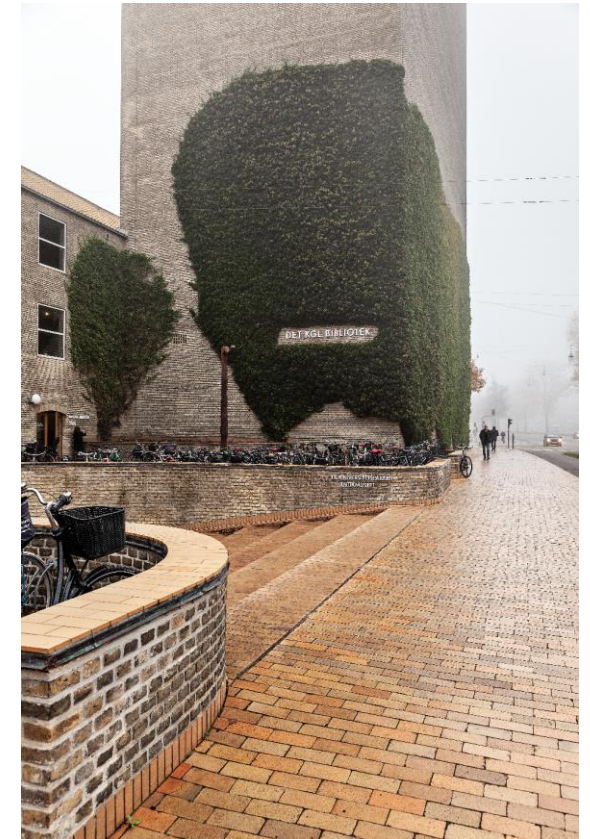
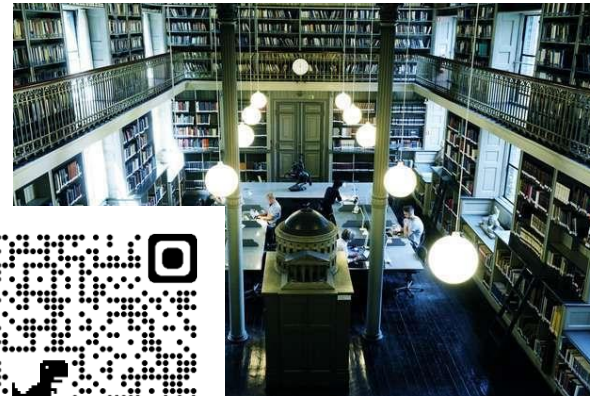

Alma was introduced in 2019



**Alma was introduced in
2019, while we – in
Copenhagen - were
preparing the transfer of
the physical collections
to a remote storage.**



Remote storage facility in Vinge

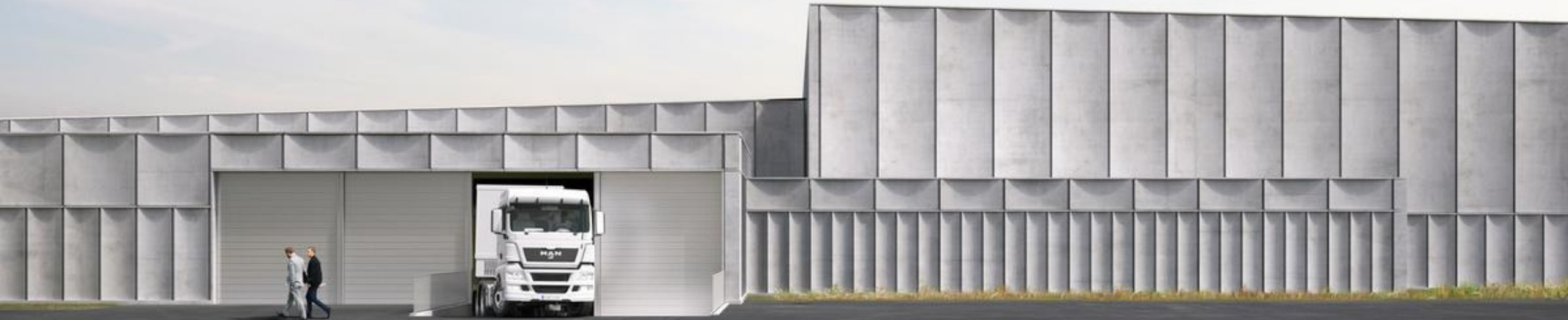

oktober 2024

47 km.s from The Black Diamond

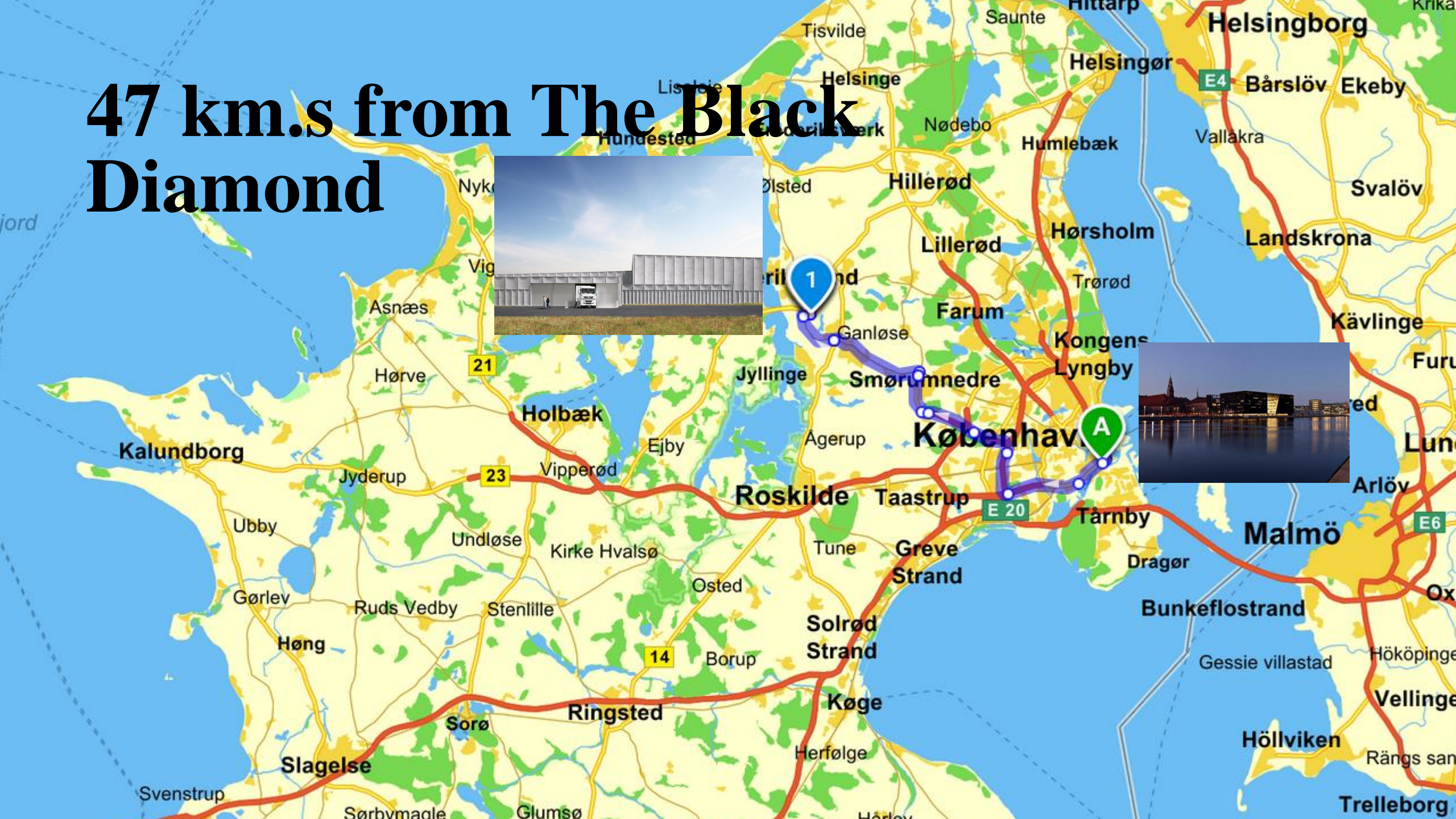

Remote storage facility

116,000 running meters of shelves in 32 rooms equipped with low-tech mobile shelving with traditional hand cranks.

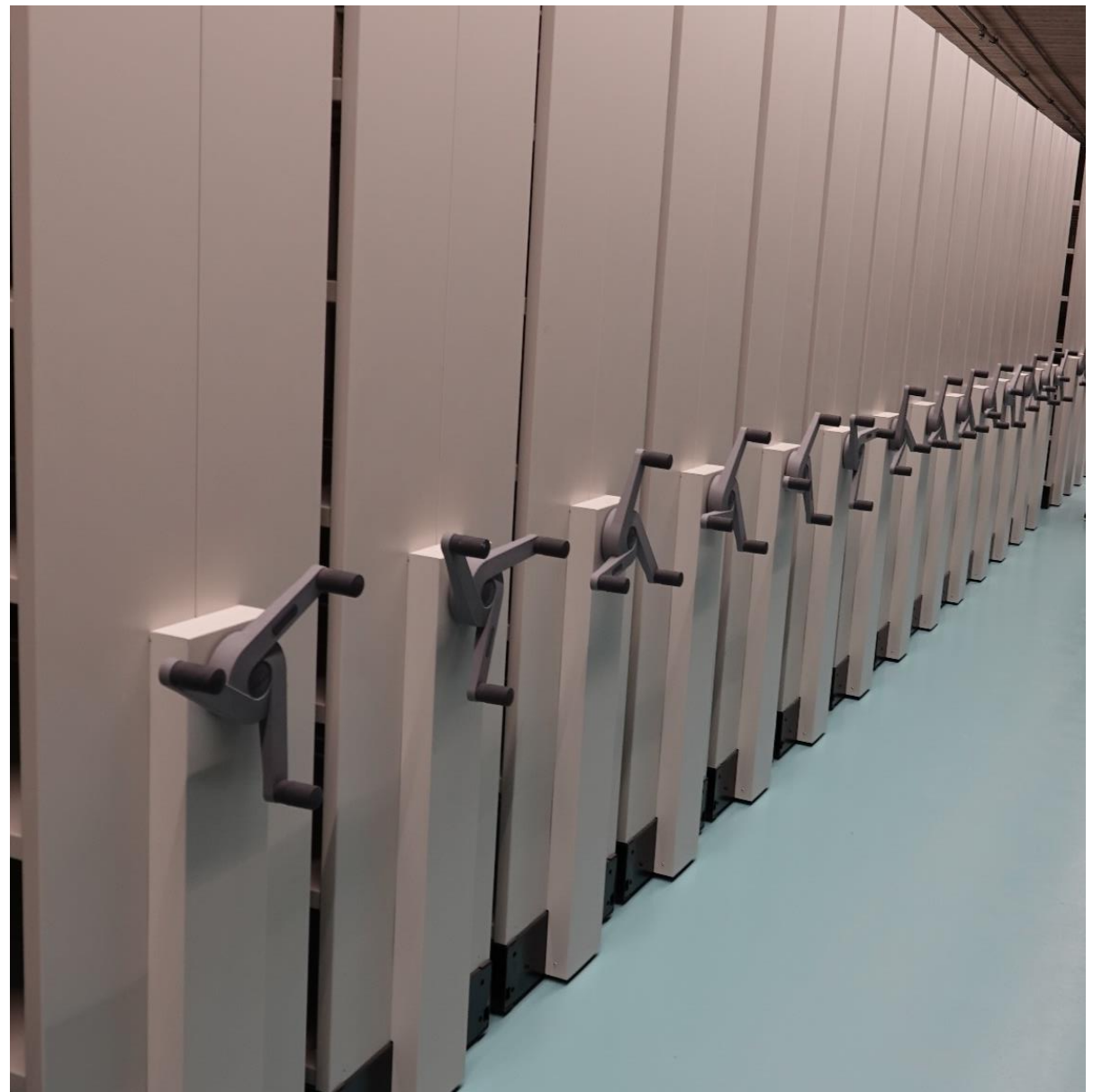

Manuscript collection



**DET KGL.
BIBLIOTEK**

Royal Danish Library

The Dalby Book (GKS 1325 4to)



**DET KGL.
BIBLIOTEK**
Royal Danish Library

Objectives

- We want the patron to be able to request the item directly in Primo
- We want to transfer metadata from Alma to the digital files when digitizing and to use the metadata in our online publishing platform.



Semi-automatic transfer of metadata

ExLibris
Alma





Welcome, Anders Toftgaard | 09/09/2024

Recent Pages

[Manage Collect...](#)
Resource Management

[Manage Sets](#)
Administration

[Manage Patron...](#)
Fulfillment

Cloud App Center



Activated Apps

Available Apps

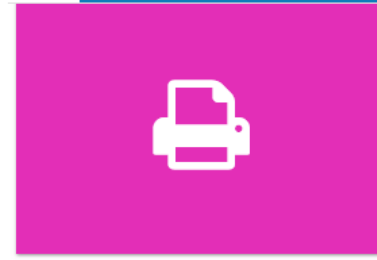

Print Bib records



SpineOMatic



Digitization addon



International standards

- “Yale University Library Manuscript Cataloging Guidelines | Yale University Library”. Set 15. januar 2021.
<https://web.library.yale.edu/cataloging/manuscript>.
- Harvard Wiki: Manuscript Section:
<https://wiki.harvard.edu/confluence/display/HoughtonTechnicalServices/Manuscript+Section>
- Österreichische Nationalbibliothek, Schweizerische Nationalbibliothek, Staatsbibliothek zu Berlin – Preußischer Kulturbesitz, Fachkollegium der Arbeitsgruppe RNA/RDA. “Ressourcenerschließung mit Normdaten in Archiven und Bibliotheken (RNAB)”, 2019.
https://www.dnb.de/DE/Professionell/Standardisierung/Standards/_content/rnab_akk.html
- *Describing Archives: A Content Standard*. 2nd edition. Chicago, IL: Society of American Archivists, 2013.
- Minnesota Historical Society. “Archival Collections: Catalog Records. MARC Coding and Data Content Guidelines”, 2013.
http://www2.mnhs.org/library/findaids/CMToolkit/BestPractices/CatalogRecords_MARCGuidelines.pdf.



Legacy metadata



**DET KGL.
BIBLIOTEK**

Royal Danish Library

Entry in the manuscript catalogue of the GKS collection from 1784

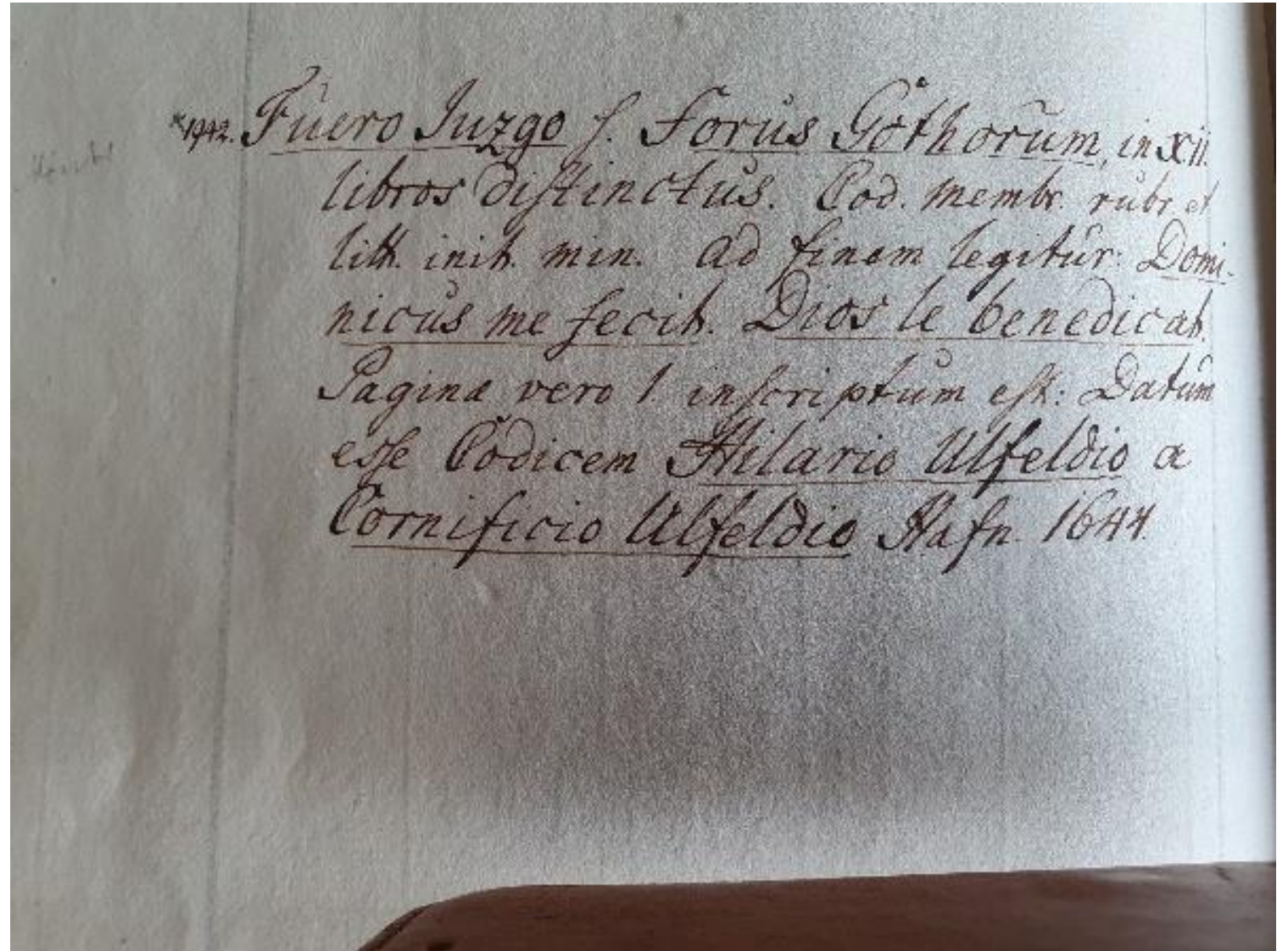



HÅNSKRIFT



Fuero Juzgo s. Forus Gothorum, in XII libros distinctus : Cod. membr. rubr. et litt. init. min. : Ad finem legitur: "Dominicus me fecit. Dios le benedicat". Pagina vero 1mæ inscriptum est: Datum esse Codicem Hilario Ulfeldio a Comificio Ulfeldio Hafn. 1644.

15??-1787

GKS 1942 kvart; **Materialet er digitaliseret - brug digital version**

 **Tilgængelig på Den Sorte Diamant, København Læsesalslån (skal bestilles - ID påkrævet til læsesal) (GKS 1942 kvart) >**

Repeated verbatim in the catalogue record





Titel Fuero Juzgo s. Forus Gothorum, in XII libros distinctus
Undertitel Cod. membr. rubr. et litt. init. min. : Ad finem legitur:
"Dominicus me fecit. Dios le benedicat". Pagina vero
1mæ inscriptum est: Datum esse Codicem Hilario
Ulfeldio a Comificio Ulfeldio Hafn. 1644

Forfatter Ukendt

Ressourcetype tekst

Omfang 1 bind

Sprog Latin

Oprindelsesland Spanien

Oprindelsesdato 1500-1787

Opstilling GKS 1942 kvart

Samling Håndskriftsamlingen

Referencer til materialet Högberg, P. (1919): Les Manuscrits espagnols de
Copenhague, side 386-88.

Kommentar Proveniens: Indlemmet i Det Kgl. Bibliotek senest
1787.

Ophavsret Materialet er fri af ophavsret

Indgår i [Hjem/Vesterlandske håndskrifter/Sprog/Latin](#)
[Hjem/Vesterlandske håndskrifter/Samlinger/GKS](#)
(Gammel Kongelig Samling)/GKS 1942 kvart

Repeated verbatim in digital
collections

Manuscript catalogues

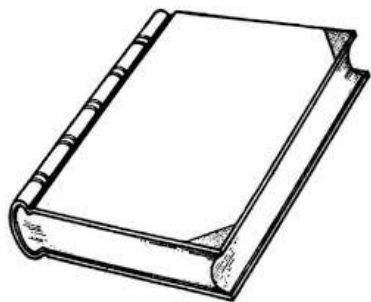

GKS

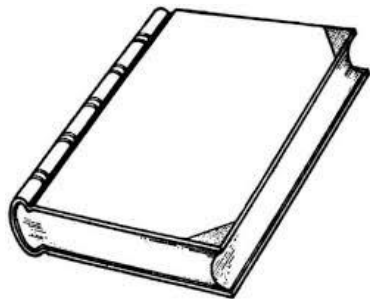

Thott

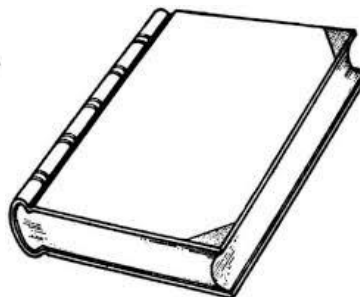

NKS

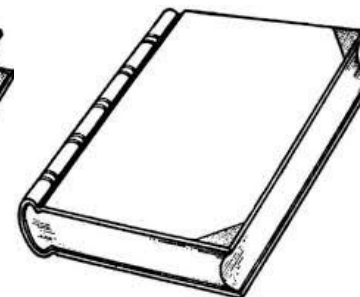

Collin

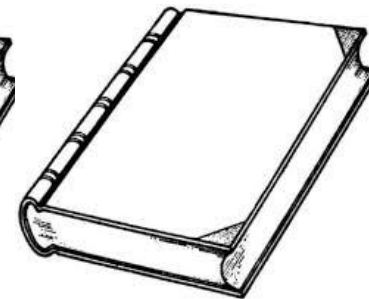

Ledreborg



Manuscript catalogues

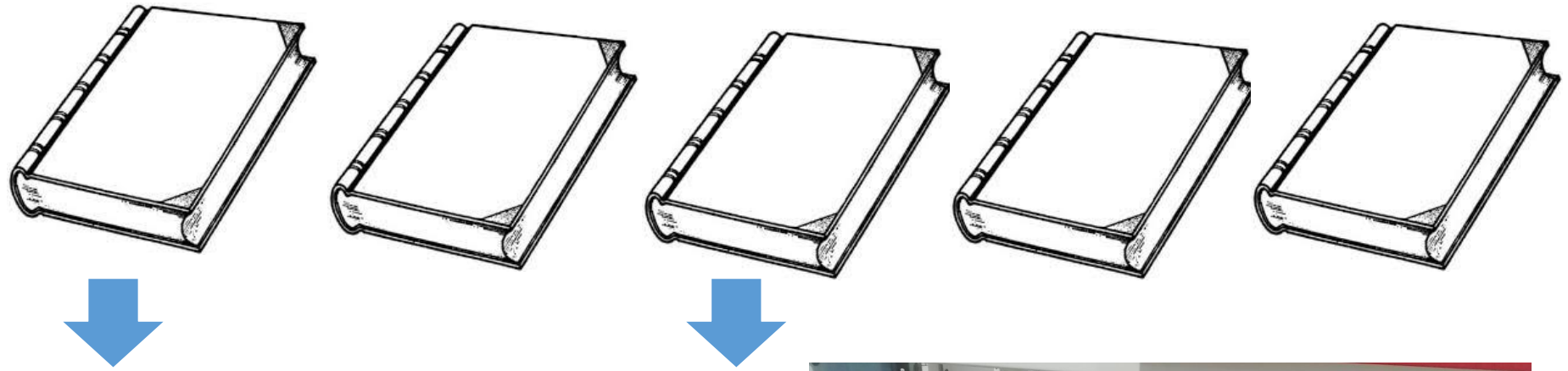

Alphabetical catalogue



Classified catalogue



Alphabetical



Classified



ExLibris
Primo



Codices



1 BIB record, 1
holding, 1 item



Archives



**DET KGL.
BIBLIOTEK**

Royal Danish Library

Normally 1 BIB-record per archive

And numerous items with descriptions which correspond to content descriptions in 505 fields in the BIB-record



Detaljer

Titel	N. F. S. Grundtvigs Arkiv.
Anden titel	Grundtvig-arkivet.
Ophav	N F S (Nicolai Frederik Severin) Grundtvig 1783-1872 præst forfatter (DBL) >
Emne	Historie. Norden. Danmark, Slesvig, Holsten, Island, Norge. Personalhistorie. Enkelte slægter og individer >
Beskrivelse	<p>Se specifikation i Lauritz Nielsen: Katalog over danske og norske Digteres Originalmanuskripter i Det Kongelige Bibliotek (1943), s. 119.</p> <p>Oprindelig inddelt i 565 fascikler (fysiske enheder), der siden er blevet til ompakket.</p> <p>Beskrevet i: Udførligt registreret i Registrant over N. F. S. Grundtvigs papirer, Bd. 1-30.</p> <p>Komplet kopi i mikrofilm haves: Ms. micro 226</p>
Indhold	<p>Æske 1: Fasc. 1-3; Prædikener 1805-1811.</p> <p>Æske 2: Fasc. 4; Prædikener 1811.</p> <p>Æske 3: Fasc. 5; Prædikener 1811-1812.</p> <p>Æske 4: Fasc. 6; Prædikener 1812.</p> <p>Æske 5: Fasc. 7; Prædikener 1812-1813.</p> <p>Æske 6: Fasc. 8; Prædikener 1813-1814.</p> <p>Æske 7: Fasc. 9-11; Prædikener 1814-1821.</p> <p>Æske 8: Fasc. 12; Prædikener 1821.</p> <p>Æske 9: Fasc. 13; Prædikener 1821-1822.</p> <p>Æske 10: Fasc. 14; Prædikener 1822-1823.</p> <p>Æske 11: Fasc. 15; Prædikener 1823.</p> <p>Æske 12: Fasc. 16; Prædikener 1823-1824.</p> <p>Æske 13: Fasc. 17; Prædikener 1824.</p> <p>Æske 14: Fasc. 18; Prædikener 1824-1825.</p> <p>Æske 15: Fasc. 19-20; Prædikener 1826-1830.</p> <p>Æske 16: Fasc. 21; Prædikener 1832.</p> <p>Æske 17: Fasc. 22; Prædikener 1832-1833.</p> <p>Æske 18: Fasc. 23; Prædikener 1833-1834.</p> <p>Æske 19: Fasc. 24; Prædikener 1834-1835.</p> <p>Æske 20: Fasc. 25; Prædikener 1835-1836.</p>

Finding aids



**DET KGL.
BIBLIOTEK**

Royal Danish Library



MANUSCRIPT

Karen Blixens arkiv.

Karen (Tanne) Blixen (-Finecke) 1885-1962 baronesse forfatter (pseudonymer: Isak Dinesen; Pierre Andrézel) (DBL); Bror Frederik von Blixen-Finecke 1886-1946 baron g m Karen Blixen; Wilhelm Dinesen 1845-1895 officer forfatter (DBL); Ingeborg Dinesen 1856-1939 g m Wilhelm Dinesen; Thomas Dinesen 1892-1979 forfatter (DBL)

19??

Karen Blixen-arkivet

 **Available at The Black Diamond, Copenhagen Reading room only (place request - restrictions may apply) (Karen Blixens arkiv (klausuleret)) and other locations >**



Quick Access

Blixen_registrant  

    1 af 27   Automatisk zoom        

1.

Oversigt

Karen Blixens arkiv i Det kongelige Bibliotek (164 kps.)

Contents

på de enkelte læg i æskerne.

I. Breve.

Æske 1: A-Da - Breve til [Karen Blixen](#) fra slægtninge.

Æske 2: Di-F - Breve til [Karen Blixen](#) fra slægtninge.

Æske 3: G-S - Breve til [Karen Blixen](#) fra slægtninge.

Æske 4: T-Ø - Breve til [Karen Blixen](#) fra slægtninge.

Æske 5: A-Andre - Breve til [Karen Blixen](#) fra fremmede.

Æske 6: Andrup-Ax - Breve til [Karen Blixen](#) fra fremmede.

Æske 7: Ba-Bec - Breve til [Karen Blixen](#) fra fremmede.

Æske 8: Bed-Bis - Breve til [Karen Blixen](#) fra fremmede.

Æske 9: Bit-Bo - Breve til [Karen Blixen](#) fra fremmede.

Æske 10: Bra-Brø - Breve til [Karen Blixen](#) fra fremmede.

Æske 11: Bu-Cars - Breve til [Karen Blixen](#) fra fremmede.

Æske 12: Cart-Ch - Breve til [Karen Blixen](#) fra fremmede.

Æske 13: Billedramme med brev fra Kong Christian X til [Karen Blixen](#)

Æske 14: Ci-Cr - Breve til [Karen Blixen](#) fra fremmede.

Æske 15: Cu-De - Breve til [Karen Blixen](#) fra fremmede.

Æske 16: Di-Ev - Breve til [Karen Blixen](#) fra fremmede.

Æske 17: Fa-Fo - Breve til [Karen Blixen](#) fra fremmede.

Æske 18: Fra-Ge - Breve til [Karen Blixen](#) fra fremmede.

Æske 19: Gi-Gra - Breve til [Karen Blixen](#) fra fremmede.

Æske 20: Gre-Haas - Breve til [Karen Blixen](#) fra fremmede.

Æske 21: Hag-Har - Breve til [Karen Blixen](#) fra fremmede.

Æske 22: Has-Henn - Breve til [Karen Blixen](#) fra fremmede.

Æske 23: Henn-Hoel - Breve til [Karen Blixen](#) fra fremmede.



H.C. Andersen's manuscripts and letters





MANUSCRIPT

Eventyr og historier : udkast, kladder eller rettede renskrifter.

H C Andersen 1805-1875 forfatter (DBL) (Author)

18??-1905

Collin 36 kvart; **Materialet er digitaliseret - brug digital version**

 **Available at The Black Diamond, Copenhagen Reading room only (place request - ID required for Reading Room) (Collin 36 kvart) >**

Get It

Please sign in to check if there are any request options. [LOGIN](#) 

[< BACK TO LOCATIONS](#)





LOCATION ITEMS

The Black Diamond, Copenhagen

Available, Reading room only (place request - ID required for Reading Room) ; Collin 36 kvart

from:01 until:06



Filters: location  volume  year  description 

[X Clear](#)

Available (0 requests) Æske 6: Indholdsfortegnelse og Register

- I. 1. [»Fyrtøjet.«] Brudstykke. (4 Bl.) — 2. »Lille Claus og store Claus.« Brudstykke. (4 Bl.) — 3. »Prindsessen paa Ærten.« (1 Bl.) — 4. [»Den lille Idas Blomster.«] Brudstykke. (2 Bl.) — 5. [»Tommelise.«] Brudstykke. (4 Bl.) — 6. »Den uartige Dreng.« (2 Bl.) — 7. [»Rejsekammeraten.«] Brudstykke. (5 Bl.) — 8. [»Lykkens Kalosker.«] Brudstykke. (3 Bl.) — 9. [»De vilde Svaner.«] Brudstykke. (2 Bl.) — 10. [»Ole Lukøje.«] Forskellige Brudstykker. (4 Bl.) — 11. [»Svinedrengen.«] Brudstykke. (1 Bl.) — 12. »Boghveden.« (1 Bl.) — 13. [»Kærestefolkene.«] (2 Bl.) — 14. [»Grantræet.«] (8 Bl.) — 15. »Stoppenaalen.« (2 Bl.) — 16. [»De røde Sko.«] (3 Bl.) — 17. »Hyrdinden og Skorsteensfeieren.« (2 Bl.) — 18. [»Holger Danske.«] (2 Bl.) — 19. »Den gamle Gadeløgte.« Brudstykke. (3 Bl.) — 20. [»Nabofamilierne.«] (4 Bl.) — 21. [»Skyggen.«] (5 Bl.) — 22. [»Den lykkelige Familie.«] (2 Bl.) — 23. [»Den gamle Gravsten.«] (2 Bl.) — 24. »Aarets Historie.« (4 Bl.) — 25. [»Det er ganske vist.«] (2 Bl.) — 26—27. »Et godt Humeur.« Kladde og Renskrift. (3 + 2 Bl.) — 28. [»Alt paa sin rette Plads.«] Brudstykke. (1 Bl.) — 29. [»Inder Pile-



	096	__ a Collin 36 kvart f Boks r a u Må kun benyttes på læsesal 5 kbh
	100	1_ a Andersen, H. C. d 1805-1875, c forfatter (DBL). 4 aut
	245	10 a Prindsessen paa Ærten.
	260	__ c [18??].
	300	__ a 1 bl.
	490	0_ a Collin 36 kvart : Eventyr og historier : v I, 3.
	500	__ a Beskrevet i Lauritz Nielsen: Katalog over danske og norske Digteres Originalmanuskripter i Det Kongelige Bibliotek (
	510	0_ a Se digital faksimile af Lauritz Nielsens katalog, s. 20. u http://www.kb.dk/permalink/2006/manus/725/dan/20/
	561	1_ a Jonas Sigismund Collin (1840-1905); indlemmet i KB 1905. 5 kbh
	595	__ a B4 1923 5 kbh
	599	__ a HAR20060628 5 kbh
	650	_4 a s04-077 Litteratur. Norden. Dansk, norsk. Romaner, fortællinger.
	700	1_ a Collin, Jonas Sigismund 4 fmo
	773	0_ w 99122393411005763
	997	__ a KBH

Details

Title	Prindsessen paa Ærten.
Creator	H C Andersen 1805-1875 forfatter (DBL) (Author) >
Subject	s04-077 Litteratur. Norden. Dansk, norsk. Romaner, fortællinger >
Description	Beskrevet i Lauritz Nielsen: Katalog over danske og norske Digteres Originalmanuskripter i Det Kongelige Bibliotek (1943), s. 20. Citation/Reference - Se digital faksimile af Lauritz Niensens katalog, s. 20.
Series	Collin 36 kvart : Eventyr og historier : I, 3. >
Creation Date	18??
Format	1 bl.
Former owner	Collin, Jonas Sigismund >
Work ID	Collin 36 kvart >
Language	Danish
Source	Royal Danish Library
Other classification	Collin 36 kvart >
Provenance	Jonas Sigismund Collin (1840-1905); indlemmet i KB 1905.
Collection Path	🏠 COLLECTIONS / Manuscript collection / 🏠 COLLECTIONS / Manuscript collection / Collin's Manuscripts Collection /



More from the same Collection

[Collin's Manuscripts Collection](#)

The Black Diamond, Copenhagen

↳ RELATED TITLE: *Eventyr og historier : udkast, kladder eller rettede renskrifter.*

Available , Reading room only (place request - ID required for Reading Room) ; Collin 36 kvart
from:01 until:06



Filters: location ▾ volume ▾ year ▾ description ▾

✕ Clear

Available (0 requests) Æske 6: Indholdsfortegnelse og Register
Loanable



Available (0 requests) Æske 5: Utrykte Eventyr
Loanable



Available (0 requests) Æske 4: Fascikel 100-131
Loanable



Available (0 requests) Æske 3: Fascikel 67-99
Loanable



Available (0 requests) Æske 2: Fascikel 34-66
Loanable



Available (0 requests) Æske 1: Fascikel 1-33
Loanable



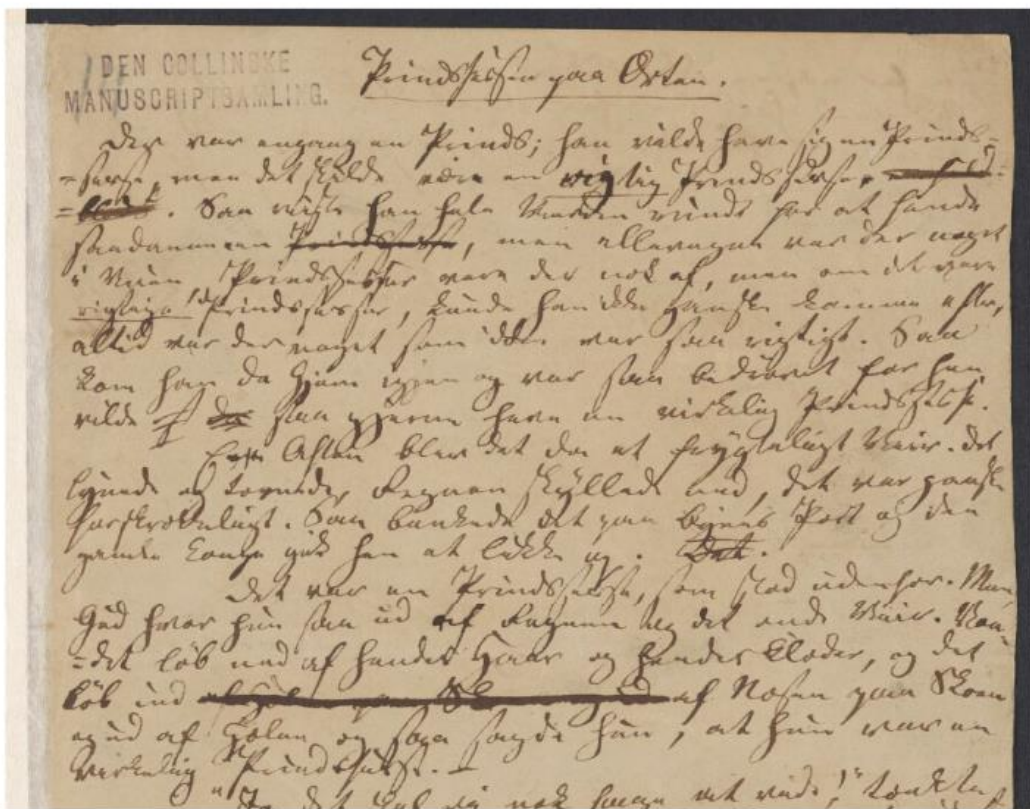

Titel Prindsessen paa Ærten : brudstykke

Forfatter Andersen, H. C.

Ressourcetype tekst

Omfang 1 bl.

Oprindelsesland Danmark

Oprindelsesdato 1800-1899

Opstilling Collin 36 kvart : Eventyr og historier : I, 3

Referencer til materialet Se digital faksimile af Lauritz Niensens katalog, s. 20.

Kommentar Beskrevet i Lauritz Nielsen: Katalog over danske og norske Digteres Originalmanuskripter i Det Kongelige Bibliotek (1943), s. 20.

Jonas Sigismund Collin (1840-1905); indlemmet i KB 1905. kbh

Proveniens: Collin, Jonas Sigismund

Ophavsret Materialet er fri af ophavsret

Indgår i [Hjem/Vesterlandske håndskrifter/Samlinger/Collin /Collin 0036 kvart](#)



Søren Kierkegaard's archive

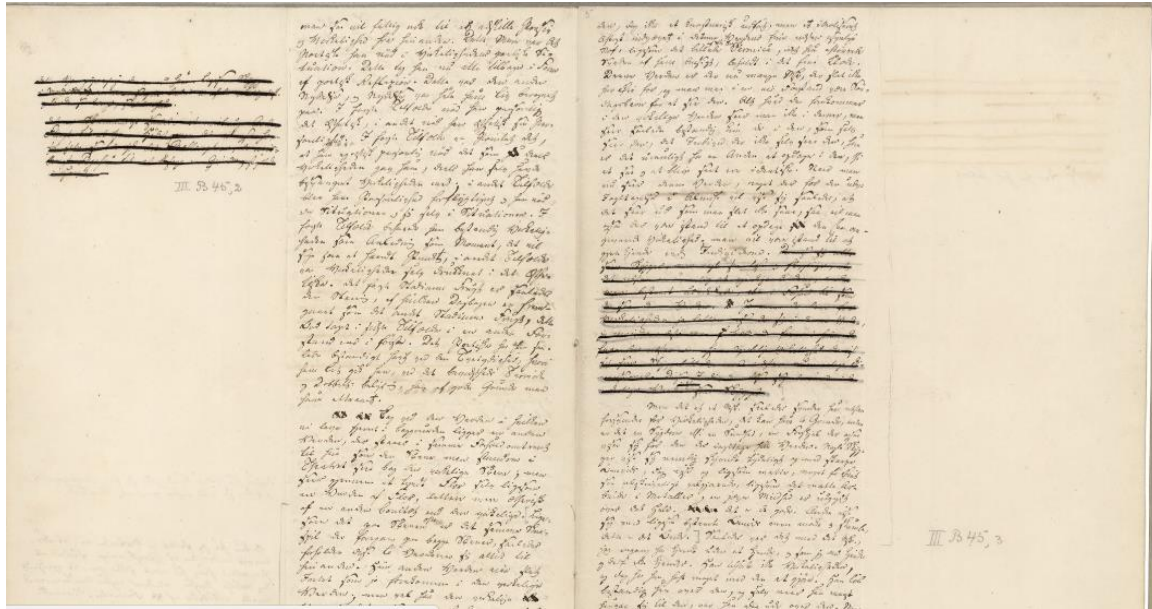

**DET KGL.
BIBLIOTEK**

Royal Danish Library

Søren Kierkegaard's archive

- 1 catalogue record per box
- 170 BIB-records based upon the manuscript finding aid



Søren Kierkegaard's archive

A. Diaries

B. Manuscripts and drafts of works

C. Excerpts and notes

D. Personal papers, family papers , letters and later added material

E. Books from Kierkegaard's Book Collection



Søren Kierkegaard's archive

- A. Diaries and the like
 - 1. Journalen NB.
 - 2. Journalen NB. (2)
 - 3. Journalen NB (3)
- B. Manuscripts and drafts of works
 - 1. ...
 - 2. ...
 - 3. ...
- C. Excerpts and notes
 - 1.
 - 2.
 - 3. ...
- D. Personal papers, family papers , letters and later added material
- E. Books from Kierkegaard's Book Collection.







HÅNSKRIFT

Søren Kierkegaard's Papirer, D 15.

Søren Kierkegaard 1813-1855 da teolog forfatter filosof (DBL) (Forfatter)

18??

SKA Søren Kierkegaards Arkiv, D. Pk. 15

 **Tilgængelig på Den Sorte Diamant, København Læsesalslån (skal bestilles) (SKA Søren Kierkegaards Arkiv, D. Pk. 15) >**

Bestilling

Log venligst ind for at se om der er bestillingsmuligheder. [LOGIN](#)

[← TILBAGE TIL OVERSIGT](#)

EKSEMPLARER

Den Sorte Diamant, København

Tilgængelig, Læsesalslån (skal bestilles) SKA Søren Kierkegaards Arkiv, D. Pk. 15

(1 af 1 eksemplar er tilgængeligt; 0 reserveringer)



Tilgængelig

Kan lånes



Detaljer

Titel

Søren Kierkegaard's Papirer, D 15.

Opby

Søren Kierkegaard 1813-1855 da teolog forfatter filosof (DBL) (Forfatter) >

001 995208745405761

005 20210611062130.0

008 000000s18?? dk ||||| 00||d dan||

035 __ |a x510345971

035 __ |a (DK-810010)000038682KBH01

035 __ |a (EXLNZ-45KBDK_NETWORK)995208745405761

096 __ |a SKA Søren Kierkegaards Arkiv, D. Pk. 15 |f Magasin |r a |u Må kun benyttes på læsesal |5 kbh

100 1_ |a Kierkegaard, Søren |d 1813-1855, |c da. teolog, forfatter, filosof (DBL), |4 aut

245 10 |a Søren Kierkegaard's Papirer, D 15.

260 __ |c 18??.

300 __ |a 1 kps.

505 0_ |a D. Pk. 15. Papirer, S. K.s eget Pragtexemplar af "Afluttende uvidenskabelig Efterskrift". 1846. - Et Bind i

561 __ |a P. C. Kierkegaard (1856) / Universitetsbiblioteket (1875) / Overført til KB 1945 |5 kbh



Afluttende uvidenskabelig Efterkrift

til

de philosophiske Emuler.

Mimisk-pathetisk-dialektisk Sammenkrift,
Erfrentielt Indlæg,

af

Johannes Climacus.

Udgiven

af

S. Kierkegaard.

Kjøbenhavn.

Hos C. A. Reitzel, Universitets-Boghandler.
Trykt i Bianco Lunos Bogtrykkeri.

1846.



D PK. 9, LÆG 3

1848 - 3/12 1849

317

(NR. 67 c)

D PK. 9, LÆG 1



001	997070058905761
005	20231124022229.0
008	230825s1843 dk 00 dan
096	__ a Søren Kierkegaards Arkiv, B. Pk. 9, læg 8 (IV B 46) f Magasin r a u Må kun benyttes på læsesal 5 kbh
100	1_ a Kierkegaard, Søren d 1813-1855, c da. teolog, forfatter, filosof (DBL), 4 aut
245	10 a Udkast til Avisartikel mod Heiberg ; p (Til "Enten-Eller". 1843).
246	1_ a Taksigelse til Hr. Professor Heiberg.
260	__ c 1843.
300	__ a 1 bl. c 171 × 206 mm.
490	0_ a Søren Kierkegaards Arkiv v B. Pk. 9, læg 8 (IV B 46)
500	__ a "Taksigelse til Hr. Professor Heiberg" blev trykt i Fædrelandet, 4. årgang, nr. 1168, søndag den 5. marts 1843
510	0_ a Barfod, c 365e (a)
510	0_ a Søren Kierkegaards Papirer, c IV B 46
510	0_ a Søren Kierkegaards Skrifter, c PH ms. 1
773	0_ w 99125084954505763
997	__ a KBH

Details

Title	Udkast til Avisartikel mod Heiberg ; (Til "Enten-Eller". 1843).
Other title	Taksigelse til Hr. Professor Heiberg.
Creator	Søren Kierkegaard 1813-1855 da teolog forfatter filosof (DBL) (Author) >
Description	"Taksigelse til Hr. Professor Heiberg" blev trykt i Fædrelandet, 4. årgang, nr. 1168, søndag den 5. marts 1843 Barfod, 365e (a) Søren Kierkegaards Papirer, IV B 46 Søren Kierkegaards Skrifter, PH ms. 1
Series	Søren Kierkegaards Arkiv B. Pk. 9, læg 8 (IV B 46) >
Creation Date	1843
Format	1 bl. 171 × 206 mm.
Work ID	Søren Kierkegaards Arkiv, B. Pk. 9, læg 8 (IV B 46) >
Language	Danish
Source	Royal Danish Library
Other classification	Søren Kierkegaards Arkiv, B. Pk. 9, læg 8 (IV B 46) >
Collection Path	🏠 COLLECTIONS / Manuscript collection / Copenhagen University Library Manuscripts Collection / Søren Kierkegaard's Archive / Group B /



More from the same Collection

Søren Kierkegaard's Archive

Søren Kierkegaard's Papers (SKA) Manuscripts, drafts, journals and other records, donated to the University Library by Kierkegaard's brother P. C. Kierkegaard in 1875.

Sort sub-collections by [Relevance](#) ▾ Sort items by [Relevance](#) ▾

Search inside the collection

 [SEARCH](#)

Sub-collections

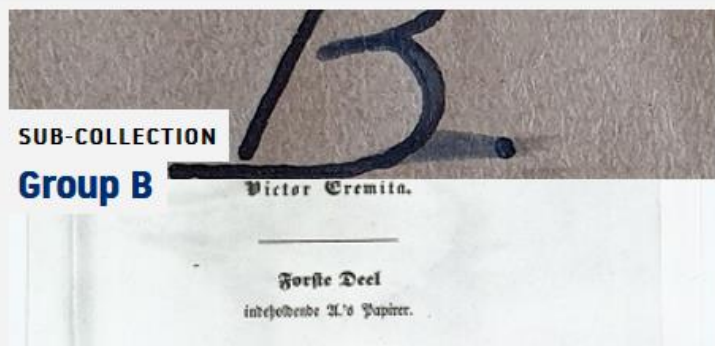

Copenhagen University Library Manuscripts Collection

These collections were transferred from the University of Copenhagen to the Royal Danish Library in 1938

Sort sub-collections by Relevance ▾

Search inside the collection 🔍

Sub-collections



SUB-COLLECTION
Additamenta



SUB-COLLECTION
E donatione variorum



SUB-COLLECTION
Rostgaard



SUB-COLLECTION
Fabricius' Collection



SUB-COLLECTION
Søren Kierkegaard's Archive

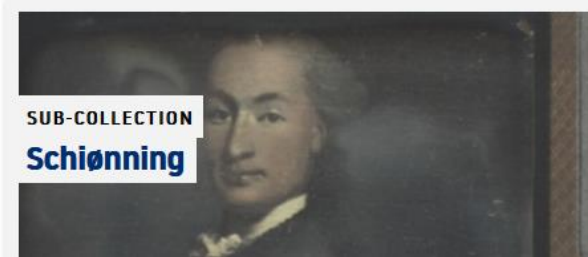

SUB-COLLECTION
Schønning

SUB-COLLECTION

Recent accessions of manuscripts and archives



SUB-COLLECTION

Personal Archives



SUB-COLLECTION

Ny Kgl. Samling



SUB-COLLECTION

Copenhagen University Library Manuscripts Collection



SUB-COLLECTION

Gammel Kgl. Samling



SUB-COLLECTION

The Thott Collection



SUB-COLLECTION

Abraham's Autograph Collection



SUB-COLLECTION

Manuscripts - Archive Finding Aids



SUB-COLLECTION

The "Accession no." Collection

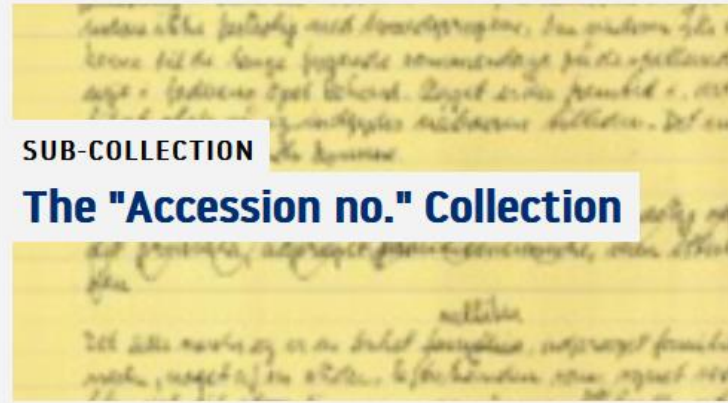

Manuscript collection

The manuscript collection contains medieval codices, collections of letters, manuscripts and archives from writers, scientists, artists and cultural figures, as well as material from cultural institutions and associations. It consists of a number of sub-collections.

Sort sub-collections by Relevance ▾

Sort items by Relevance ▾

Search inside the collection

SEARCH

Sub-collections



SUB-COLLECTION

Recent accessions of manuscripts and archives



SUB-COLLECTION

Personal Archives



SUB-COLLECTION

Ny Kgl. Samling

Collections

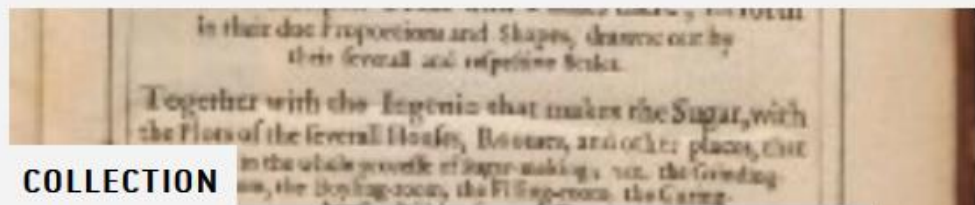

COLLECTION

Danish West Indies colonial history



COLLECTION

Music collection

Contains registrants over the content of miscellaneous music archives and links to catalog entries for selected digital sheet music.



COLLECTION

Manuscript co



COLLECTION

Danish Folklore Archives



COLLECTION

Rare Book collections



COLLECTION

Collections at



Related records and collections make hierarchical structures possible



Database of letters



**DET KGL.
BIBLIOTEK**

Royal Danish Library

Database of letters



BREVREGISTRANT

BREVE FRA

H.S. Henriette
Hendriksen - Hertz

BREVREGISTRANT

BREVE FRA

Holberg - Holst

BREVREGISTRANT

BREVE FRA

P.W. Heiberg - F. Hendriksen

BREVE FRA

Hio - Holbek

BREVREGISTRANT

BREVE FRA

Fr. Hegel - P.A. Heiberg
S-Ø

BREVREGISTRANT

BREVE FRA

Henrik Hertz - Hinz

BREVE TIL

(1854-1927)
J.L. Heiberg - Helm
E-Ø

BREVE TIL

P. Hjort - A. Holm

BR

Jacob J

BREVREGISTRANT

BREVE TIL

(1854-1928)
Hær - J.L. Heiberg
A-D

BREVREGISTRANT

BREVE TIL

R. Henriques - P. Hjort
O-Z A-E

BREVREGISTRANT

BREVE TIL

Vald. Hv

BREVREGISTRANT

BREVE TIL

Hans -

BREVREGISTRANT

BREVE TIL

Help - R. Henriques
A-N

BREVREGISTRANT

BREVE TIL

C. Hol

[Department of Manuscripts & Rare Books](#)[Centre for Manuscripts & Rare Books](#)[Manuscript Department](#)[Tasks and new acquisitions](#)[Manuscript collections and private archives](#)[Manuscript databases and catalogues](#)[Ordering and use of manuscripts](#)[E-manuscripts](#)[Rare books](#)[Loans for exhibitions](#)[The National Library](#)

The Manuscript Collection's Letter Base

Sender: Recipient: Title: Year:

A1 ID*

	A	B	C	D	E	F	G	H	I
	ID*	TYPE*	TITEL*	SAMLING*	DATERING*	FRA	TIL	AFSENDER*	MODTAGER*
1	1	Post	til Viggo Stuckenberg, 13.7.1887	NKS 5091, 4°	1887		1887	A., Dagny og Poul	Stuckenberg, Viggo
2	2	Post	til Laur. Skau, Kbhn., 25.9.1848	NKS 2° 1727 I	1848		1848	B., A.	Skau, Laur.
3	3	Post	til Anton Hansen, no. 79, 13.9.1921	NKS 4606, 4° 1	1921		1921	M., A.	Hansen, Anton
4	4	Post	til Jo. Alb. Fabricius, 8.10.1730	Fabr. 104-123, 4° nr. 1	1730		1730	Aa, Janssonii van der	Fabricius, Jo. Alb.
5	5	Post	til Anton Juell, pianist, 1912 (1)	NKS 4704, 4°	1912		1912	Aabel, Hauk, norsk skuespiller	Juell, Anton
6	6	Post	til M. Arnbak, 27.2.1942	NKS 5067, 4°	1942		1942	Aabenraa Antikvitetshandel	Arnbak, M.
7	7	Post	til Frederik Barfod, 25.3.1864	NKS 4652, 4°. I. 1.	1864		1864	Aaberg, C.	Barfod, Frederik
8	8	Post	til Lars Dinesen, 1885-90 (5)	NKS 2631, 2°. I.	1885-1890		1885 1890	Aaberg, C.P., politiker	Dinesen, Lars
9	9	Post	til Ludv. Schrøder og Charlotte Schrøder, 14 breve: 12.8.1894, 14.7.1897	NKS 3550, 4°	1894-1897		1894 1897	Aaberg, C.P., (gaardejer, folketingsmand)	Schrøder, Ludv.
10	10	Post	til Frederik Barfod, 6.9.1864	NKS 4652, 4°. I. 1.	1864		1864	Åberg, E. Ludv.	Barfod, Frederik
11	11	Post	til H. Høffding, 8.10.1891, 3.11.1892	NKS 3815 4°	1892		1892	Åberg, L.H.	Høffding, H.
12	12	Post	til Holger Begtrup, 14 br., 10.5.1887, 6.10.1932	NKS 3912, 4°	1887-1932		1887 1932	Aaberg, M.	Begtrup, Holger
13	13	Post	til Ludv. Schrøder, Thisted, 15.5.1886	NKS 3550, 4°	1886		1886	Aaberg, M., (red. af "Thisted Amts Tidende")	Schrøder, Ludv.
14	14	Post	til Jeppe Aakjær, 2.1.1914	NKS 4725, 4°	1914		1914	Kristensen, J.P. Aabo	Aakjær, Jeppe
15	15	Post	til J. Saxtorph-Mikkelsen, 1926-38 (4)	NKS 2670, 2°	1926-1938		1926 1938	Aabrink, Axel, (og frue)	Saxtorph-Mikkelsen, J.
16	16	Post	til Axel Sørensen, 1 br. 1904	NKS 2905, 4°	1904		1904	Aaby, Caroline	Sørensen, Axel
17	17	Post	til Kammerraad C.F. Herbst, Flensb, 14.10.1862	NKS 2473, 4°	1862		1862	Aabye	Herbst, C.F.
18	18	Post	til R.T. Rasmussen. Præst. 1 udat. 24.12.1918	Troensegaard I 2°	1918		1918	Aabye. (Alm. hospital)	Rasmussen. R.T.

Server Overview Layout Metadata Tools

Logout atof@kb.dk

Document... Find

Document Manager User Manager

Versions Jobs

Recent documents... User activity

Collections: KB_HS_BrevReg (52270, Editor) Col-ID

Documents Model Data

1-56 / 56 1 1 Doc-ID

ID	Title	Pa...	Uploader	Uploaded
23...	Robert_01	14...	jme@kb...	Fri Nov 0...
23...	Klint_Bentsen_01	18...	jme@kb...	Fri Nov 0...
23...	Heinesen_01	179	jme@kb...	Fri Nov 0...
23...	PH_01	18...	jme@kb...	Thu Oct ...
23...	Gelsted_01	10...	jme@kb...	Thu Oct ...
23...	Lis_03	13...	jme@kb...	Thu Oct ...
23...	Lis_02	14...	jme@kb...	Thu Oct ...
23...	Lis_01	17...	jme@kb...	Thu Oct ...
23...	Blixen_02	15...	jme@kb...	Thu Oct ...
23...	Blixen_01	15...	jme@kb...	Thu Oct...
23...	JVJ_01	816	jme@kb...	Thu Oct ...
23...	Johannes_J_02	18...	jme@kb...	Thu Oct ...
23...	Johannes_J_01_M	17...	jme@kb...	Thu Oct ...
23...	H_Jacobsen_01	567	jme@kb...	Thu Oct ...
23...	H_Nielsen_01	13...	jme@kb...	Thu Oct ...
23...	Bergstedt_01	16...	jme@kb...	Thu Oct ...
23...	Hammerich_01	24...	jme@kb...	Thu Oct ...
23...	Gyldendal_14_M	17...	jme@kb...	Thu Oct ...
23...	Gyldendal_13_M	17...	jme@kb...	Thu Oct ...

100 Filter

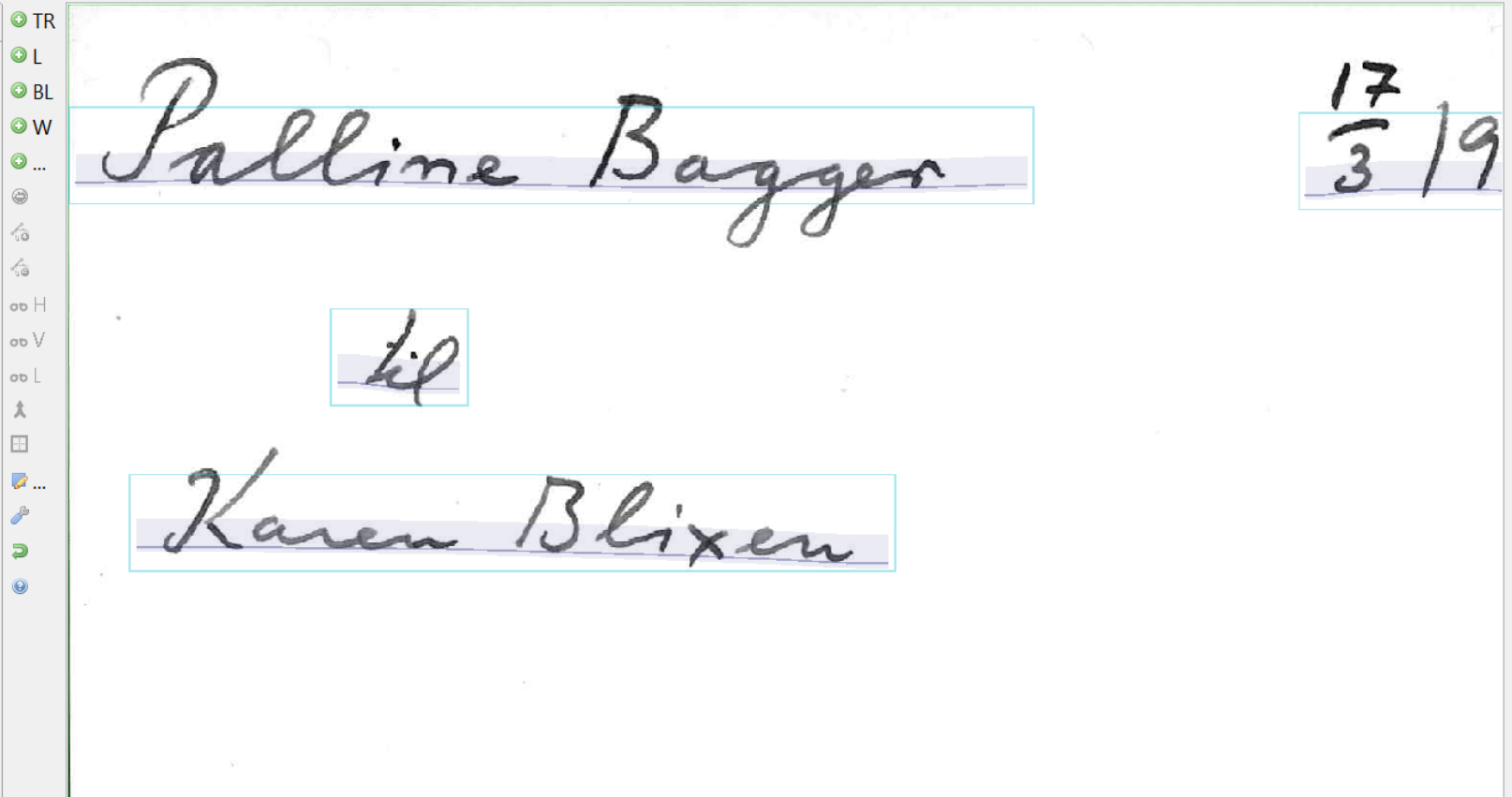

1-1 Palline Bagger

1-2 17/3 1939

1-3 til

1-4 Karen Blixen

Klip Kopier Sæt ind Formatpencil Udklipsholder

Calibri 18 A A Ombryd tekst Standard

F K U Flet og centrering Tal

Betinget formatering som tabel Typografier

Indsæt Slet Formatér Celler

Autosum Fyld Ryd Sortér og Søg og filter vælg Redigering

A1 ALMA Import: HS BrevReg:

A B C D E F G H I J K L M N O P Q R S T U V W X Y Z AA AD AE AF AG AH AI AJ AK

ALMA Import: HS BrevReg: Palsbo

Sortér: Poster

Rens data

Eksportér MARC

Hovedpost MMS-ID: 99122993412105763

Sortér: STA

Sortér: Minus ekstra

Tilføj Line#

Forfatter
Titel

Navn Titel Årstal Kode Titel Dato/interval

Record	Line	Include	05_Status	06_Type	07_Level	06_Dtype	07_Date1	11_Date2	15_Place	18_Comp	20_MuFrm	21_Parts	22_Audic	23_ItmFrm	24_Acmp_1	24_Acmp_2	24_Acmp_3	24_Acmp_4	24_Acmp_5	24_Acmp_6	30_Litt_1	31_Litt_2	33_Arr	35_Lang	38_Modify	39_Source	100_\$a	100_\$c	100_\$d	100_\$4	100_i1	100_i2	245_\$a	245_\$f
1	1	x		e	1881	1121	dk																				Alexandra	dronning af England		aut	1	#	Brev fra Alexandra til frk. Knudsen	21. november 1881
2	1	x		e	1884	0729	dk																				(Carmen Sylva), Elisabeth	dronning af Rumænien		aut	1	#	Brev fra Elisabeth (Carmen Sylva) til Ulbach	29. juli 1884
3	1	x		e	1915	0520	dk																				[Müllertz], Mogens			aut	1	#	Brev fra Mogens [Müllertz] til Julius Lassen	20. maj 1915
4	1	x		e	1862	0102	dk																				About, Edmont			aut	1	#	Brev fra Edmont About til Schlittenbach	2. januar 1862
5	1	x		e	1855	0328	dk																				Abrahams, N.C.L.			aut	1	#	Brev fra N.C.L. Abrahams til C.F. Allen	28. marts 1855

Vejledning

Data

IMPORT

LUT

LUT_LDR

LUT_008_General

LUT_008_Music

BIB

BIB-Fields

HOL

HOL-Fields

Soon:

—300.000 records of letters and
correspondance will be imported into
Alma as BIB-records linked via 773 fields
to items of individual archives.



Problems in Alma/Primo



**DET KGL.
BIBLIOTEK**

Royal Danish Library

Problem

Multiple holdings: difficult to handle for the patron



**DET KGL.
BIBLIOTEK**

Royal Danish Library

The Black Diamond, Copenhagen

Available , Reading room only (place request) ;

Håndskriftsamlingen, Johannes V. Jensens arkiv



The Black Diamond, Copenhagen

Available , Reading room only (place request) ;

Håndskriftsamlingen, Johannes V. Jensens arkiv



The Black Diamond, Copenhagen

Available , Reading room only (place request) ;

Håndskriftsamlingen, Johannes V. Jensens arkiv



The Black Diamond, Copenhagen

Available , Reading room only (place request - ID required for

Reading Room) ; Johannes V. Jensens arkiv



The Black Diamond, Copenhagen

Available , Reading room only (place request - restrictions may

apply) ; Johannes V. Jensens arkiv



Problem

Multiple holdings: difficult to handle
for the patron
Possible solution: Making the filters
more visible



**DET KGL.
BIBLIOTEK**

Royal Danish Library

Filters: location ▼ volume ▼ year ▼ description ▼

✕ Clear

The Black Diamond, Copenhagen

Available , Reading room only (place request) ;

Håndskriftsamlingen, Johannes V. Jensens arkiv



The Black Diamond, Copenhagen

Available , Reading room only (place request) ;

Håndskriftsamlingen, Johannes V. Jensens arkiv



The Black Diamond, Copenhagen

Available , Reading room only (place request) ;

Håndskriftsamlingen, Johannes V. Jensens arkiv



The Black Diamond, Copenhagen

Available , Reading room only (place request - ID required for

Reading Room) ; Johannes V. Jensens arkiv



The Black Diamond, Copenhagen

Available , Reading room only (place request - restrictions may

apply) ; Johannes V. Jensens arkiv



Problem

Restricted use



**DET KGL.
BIBLIOTEK**

Royal Danish Library

Problem

Restricted use

Solution:

Locations with restrictions which require release in “pick from shelf” instead of automated printing.

506 field in holding(s)



**DET KGL.
BIBLIOTEK**

Royal Danish Library

Workflow in Libanswers

Request

for access to private archives from the Royal Danish Library's collections



**DET KGL.
BIBLIOTEK**
Royal Danish Library

Special rules apply for access to private archives that contain documents younger than 75 years. This is due, among other things, to the fact that the library often does not know the exact contents in detail.

Archives often contain information, which may be covered by the rules on the protection of privacy, the rules on personal data, and the rules on copyright. In addition, for some archives there may be special clauses set by the donor that limit use.

It is therefore necessary to apply for access stating a legitimate purpose. With your signature on this form, you apply for access and at the same time accept the conditions that apply, if access is granted.

Applicant

Name

Address:

Email address:

Private records you are seeking access to

Archival name:

Signature of the archival records:

Your purpose of access – tick one or more

- Written presentation or other publication
- Professional purpose
- Other, e.g. genealogical research

Problem

Restricted use

Solution:

Locations with restrictions which require release in “pick from shelf” instead of automated printing.

506 field in holding(s)

Perhaps an item policy which leads the patron to libanswers



**DET KGL.
BIBLIOTEK**

Royal Danish Library

Contact

Anders Toftgaard
atof@kb.dk



**DET KGL.
BIBLIOTEK**

Royal Danish Library